



Complete product range 2014

www.don-quichotte.de

Don Quichotte®



At home on the construction site

Our fastening and installation products have been used daily around the world for over 90 years. On the construction site or at home, Don Quichotte products are used in the following areas:

Iron goods

Electrical installations

Sanitary installations

Construction industry, e.g. dry construction

Professional tradespeople react quick and flexibly as a matter of course. We can offer you a large range of appropriate high-quality products, which we have arranged in four clear categories:

1. Fastening and retaining

2. Connecting and distributing

3. Routing and guiding

4. Prevention and protection

1 Fastening and retaining 9

Nail and screw, anchor, cable tie, installation strip, insulating tape, knotted chain, tool

2 Connecting and distributing 73

Junction box, terminal, sleeve, heat-shrinkable hose, accessories for concealed mounting (dry core drill, separating discs)

3 Routing and guiding 91

Connector range, nail disc, nail clip, pipe clamp and fastening clip, grouped support, clamp strap, profile rail, clamp clip

4 Prevention and protection 143

Strip earthing clip for pipes, earth connection clip, equipotential bonding rail, earthing rod and connector

5 Appendix 151

Pictogram explanation, alphabetic table of contents, numeric directory, terms and conditions of sale and delivery

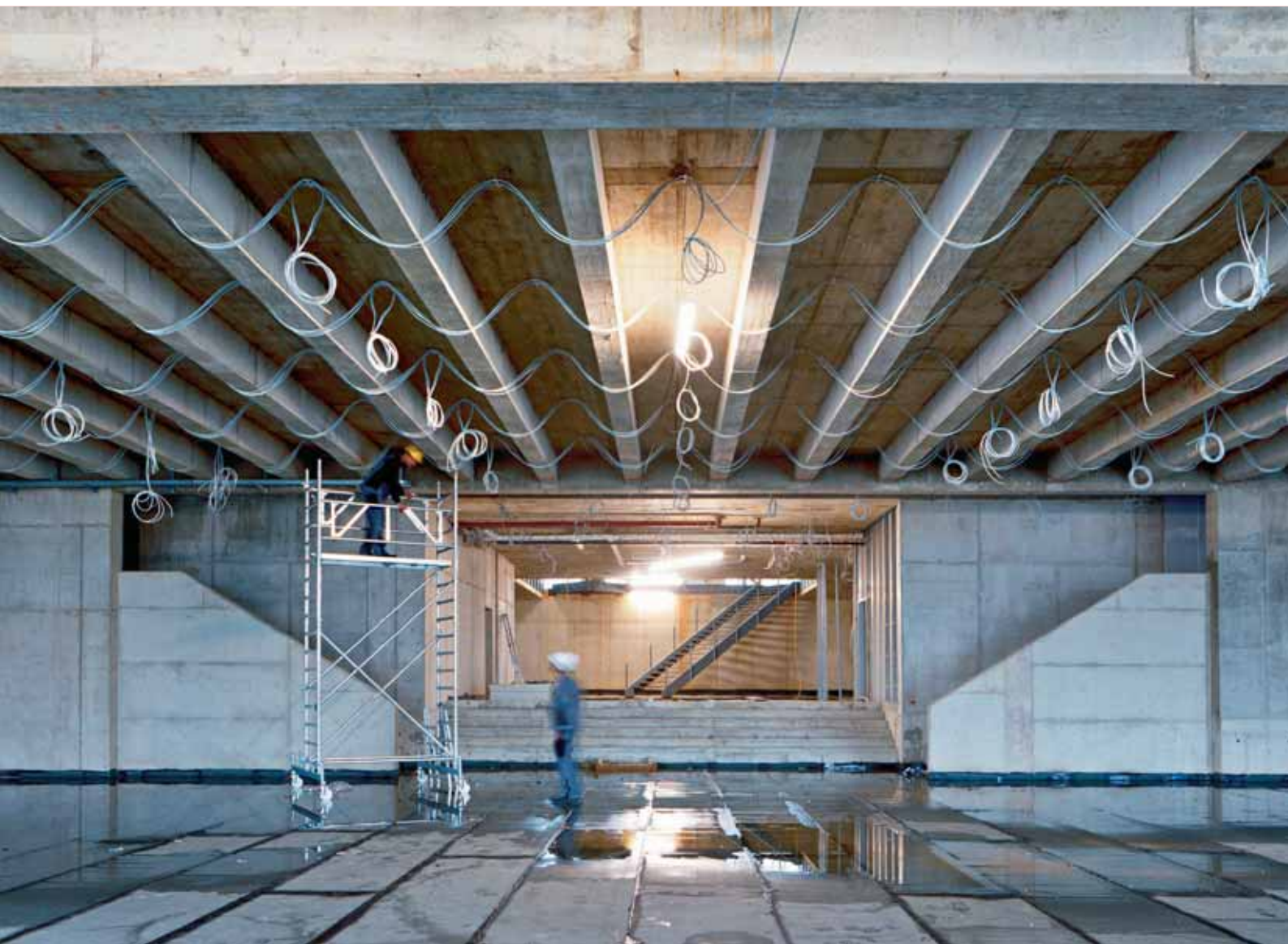

You can rely on it!

Professional work requires professional products. Our concept: Quality, additional benefits, fair price. This ensures both quick, user-friendly mounting and maximum economy. You can rely on it!

1. Quality

Don Quichotte products stand for the highest level of reliability. The quality necessary for this is created using state-of-the-art production systems and conscientious quality control.



2. Well-thought-out products

Thanks to 90 years of experience in the industry, our users can profit from innovative products and well-thought-out technical solutions.



3. Time savings

Time is money! The high quality and easy mounting of our products allow effective, rapid work and thus ensure the highest level of economy.



4. Cost-effectiveness

At Don Quichotte, you will receive the best brand quality at a fair price in every product area.



5. Service

Short-term availability and direct order processing mean that we are able to help you as a strong, reliable and competent partner.





Over 90 years of manufacturing competence

Fastening and installation systems for everyday work. High-quality, quick, time-saving mounting. Those are the hallmarks of the Don Quichotte brand.

Over 90 years of manufacturing experience, an excellent knowledge of the industry and rapid order processing make Don Quichotte your strong, reliable trade brand.



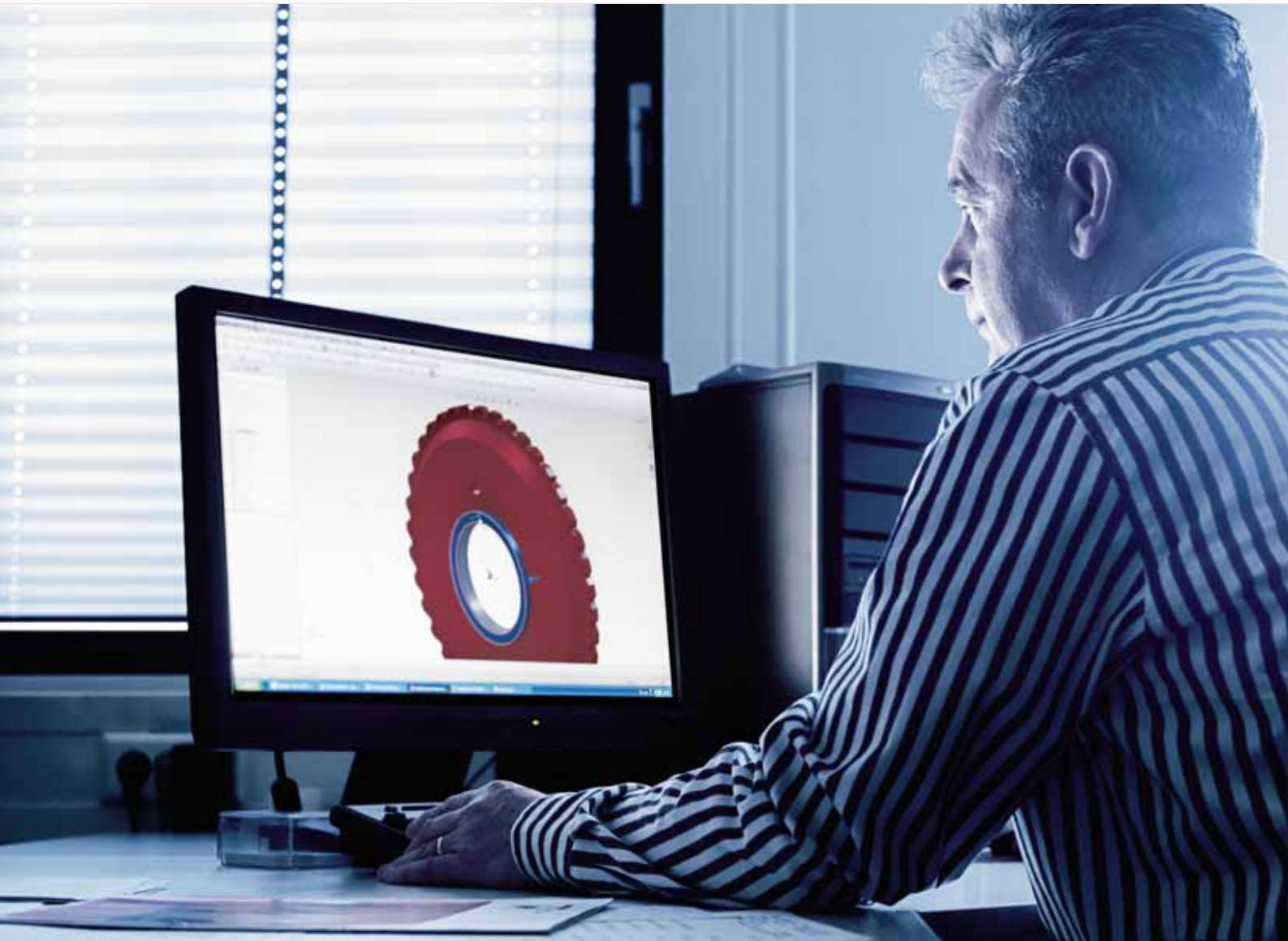



Fastening and retaining, e.g. with Total-Fix nail anchor

1 Fastening and retaining

Nail and screw	10
Anchors	43
Cable tie	59
Installation strip	63
Insulating tape	65
Knotted chain and accessories	67
Tool	68

CHARACTERISTIC:

- Manufactured from special electric steel with a high carbon content
- Hardened and annealed on modern, fully automatic production lines in a continuous process under strict quality control
- Corrosion protection: Electrogalvanised or galvanised
- High-hardness steel nails, coupled with an extremely high tensile and break resistance to ensure absolute safety during work



Steel nail, smooth, rounded head, blue annealed (KC004/KS084)

To fasten hard or soft wood in concrete or stone.

Steel, Hardened Bright

Type	Shank Ø		Contents PU	Weight kg/PU	Shipping box PU	Item No.
	mm	mm				
KS004 1,5x25	1.50	25.00	2,667	1.00	25	997 00 9
KS004 2x16	2.00	16.00	100	0.04	200	930 48 8
KS004 2x16	2.00	16.00	2,604	1.00	25	929 81 5
KS004 2x20	2.00	20.00	100	0.05	200	930 49 6
KS004 2x20	2.00	20.00	2,083	1.00	25	929 82 3
KS004 2x23	2.00	23.00	100	0.06	200	930 25 0
KS004 2x25	2.00	25.00	100	0.06	200	930 50 9
KS004 2x25	2.00	25.00	1,639	1.00	25	929 83 1
KS004 2x30	2.00	30.00	100	0.07	200	930 51 7
KS004 2x30	2.00	30.00	1,369	1.00	25	929 85 8
KS004 2x30	2.00	30.00	3,423	2.50	1	987 20 6
KS004 2x35	2.00	35.00	100	0.08	200	930 52 5
KS004 2x35	2.00	35.00	1,190	1.00	25	929 86 6
KS004 2x40	2.00	40.00	100	0.10	120	930 53 3
KS004 2x40	2.00	40.00	1,042	1.00	25	929 87 4
KS004 2x40	2.00	40.00	2,605	2.50	1	987 16 9
KS084 2x60	2.00	60.00	100	0.14	70	973 91 2
KS004 2,5x25	2.50	25.00	100	0.10	200	930 54 1
KS004 2,5x25	2.50	25.00	1,062	1.00	25	929 88 2
KS004 2,5x30	2.50	30.00	877	1.00	25	929 89 0
KS004 2,5x30	2.50	30.00	100	0.11	200	930 56 8
KS004 2,5x35	2.50	35.00	758	1.00	25	929 90 3
KS004 2,5x40	2.50	40.00	100	0.15	120	930 58 4
KS004 2,5x40	2.50	40.00	649	1.00	25	929 91 1
KS004 2,5x40	2.50	40.00	1,623	2.50	1	987 04 6
KS004 2,5x50	2.50	50.00	100	0.19	80	930 60 5
KS004 2,5x50	2.50	50.00	518	1.00	25	929 94 6
KS004 2,5x50	2.50	50.00	1,328	2.50	1	986 99 1
KS084 2,5x60	2.50	60.00	100	0.23	70	930 61 3
KS084 2,5x60	2.50	60.00	442	1.00	25	929 95 4
KS004 3x30	3.00	30.00	100	0.16	200	930 64 8
KS004 3x30	3.00	30.00	625	1.00	25	929 97 0
KS004 3x40	3.00	40.00	100	0.22	120	930 66 4
KS004 3x40	3.00	40.00	463	1.00	25	929 99 7
KS004 3x40	3.00	40.00	1,157	2.50	1	986 85 2
KS004 3x50	3.00	50.00	100	0.27	80	930 68 0
KS004 3x50	3.00	50.00	380	1.00	25	930 01 5
KS004 3x50	3.00	50.00	950	2.50	1	986 80 1
KS004 3x60	3.00	60.00	100	0.32	70	930 69 9
KS004 3x60	3.00	60.00	311	1.00	25	930 02 3
KS004 3x60	3.00	60.00	776	2.50	1	986 78 0
KS004 3x70	3.00	70.00	100	0.38	70	986 76 4
KS004 3x70	3.00	70.00	263	1.00	25	933 17 9
KS004 3,4x40	3.40	40.00	344	1.00	25	933 27 5
KS004 3,4x50	3.40	50.00	100	0.36	70	986 67 6
KS004 3,4x50	3.40	50.00	275	1.00	25	933 18 7
KS004 3,4x60	3.40	60.00	100	0.45	70	986 64 1
KS004 3,4x60	3.40	60.00	224	1.00	25	933 19 5
KS004 3,4x70	3.40	70.00	100	0.52	70	986 60 9
KS004 3,4x70	3.40	70.00	192	1.00	25	933 20 8
KS004 3,4x80	3.40	80.00	100	0.60	70	986 58 8
KS004 3,4x80	3.40	80.00	167	1.00	25	933 21 6

Steel nail, smooth, rounded head, blue annealed (KC004/KS084)

To fasten hard or soft wood in concrete or stone.

Steel, Hardened Bright

Type	Shank Ø mm	Nail length mm	Contents	Weight	Shipping	Item No.
			PU pcs	kg/PU	box PU	
KS004 4,2x70	4.20	70.00	100	0.69	40	937 89 0
KS004 4,2x80	4.20	80.00	100	0.81	40	987 09 7
KS004 4,2x90	4.20	90.00	100	0.88	40	987 07 0
KS004 4,2x90	4.20	90.00	113	1.00	25	933 22 4
KS004 4,2x100	4.20	100.00	100	1.01	40	987 05 4
KS004 4,2x100	4.20	100.00	99	1.00	25	933 23 2



Steel nail, smooth, rounded head (KC110/KS123)

To fasten hard or soft wood in concrete or stone.

Steel, Hardened Electrogalvanised

Type	Shank Ø mm	Nail length mm	Contents	Weight	Shipping	Item No.
			PU pcs	kg/PU	box PU	
KS110 2x20	2.00	20.00	100	0.05	200	995 89 8
KS110 2x25	2.00	25.00	100	0.06	200	960 78 3
KS110 2x30	2.00	30.00	100	0.07	200	948 07 1
KS110 2,5x25	2.50	25.00	100	0.10	200	943 31 8
KS110 2,5x30	2.50	30.00	100	0.11	200	925 17 9
KS110 3x40	3.00	40.00	100	0.22	120	948 65 3
KS110 3x50	3.00	50.00	100	0.27	80	943 32 6
KS110 3,4x25	3.40	25.00	100	0.18	200	943 35 0
KS110 3,4x30	3.40	30.00	100	0.22	120	943 29 7
KS110 3,4x40	3.40	40.00	100	0.30	80	943 36 9
KS110 3,4x45	3.40	45.00	100	0.33	80	943 37 7
KS110 3,4x50	3.40	50.00	100	0.37	70	943 38 5
KS110 3,4x60	3.40	60.00	100	0.44	70	943 40 6
KS110 3,4x65	3.40	65.00	100	0.47	70	943 41 4
KS110 3,4x70	3.40	70.00	100	0.51	70	943 42 2
KS110 3,4x75	3.40	75.00	100	0.55	70	943 43 0
KS110 3,4x80	3.40	80.00	100	0.58	70	943 44 9
KS123 3,4x90	3.40	90.00	100	0.65	70	943 45 7
KS123 3,4x100	3.40	100.00	100	0.75	70	936 60 1



Steel nail, smooth, half flat rounded head, blue annealed (KS008)

To fasten hard or soft wood in concrete or stone.

Steel, Hardened Bright

Type	Shank Ø mm	Nail length mm	Contents	Weight	Shipping	Item No.
			PU pcs	kg/PU	box PU	
KS008 2,5x16	2.50	16.00	1,370	1.00	25	987 51 3
KS008 2,5x25	2.50	25.00	936	1.00	25	940 36 0
KS008 2,5x30	2.50	30.00	877	1.00	25	987 47 6
KS008 2,5x40	2.50	40.00	663	1.00	25	987 44 1



Steel nail



Steel nail, smooth, rounded head (KC014)

To fasten nail clamps and nail discs in concrete or stone.

Steel, Hardened Electrogalvanised

Type	Shank Ø		Nail length mm	Contents PU pcs	Weight kg/PU	Shipping box PU	Item No.
	mm	mm					
KC014 2x40	2.00		40.00	100	0.10	120	967 23 8
KC014 2x50	2.00		50.00	100	0.12	70	967 24 2
KC014 2x60	2.00		60.00	100	0.14	70	967 24 6



Steel nail, smooth, countersunk head, blue annealed (KS006)

To fasten hard or soft wood in concrete or stone.

Steel, Hardened Bright

Type	Shank Ø		Nail length mm	Contents PU pcs	Weight kg/PU	Shipping box PU	Item No.
	mm	mm					
KS006 2x16	2.00		16.00	100	0.04	200	930 77 9
KS006 2x16	2.00		16.00	2,615	1.00	25	930 26 9
KS006 2x20	2.00		20.00	100	0.05	200	930 78 7
KS006 2x20	2.00		20.00	2,092	1.00	25	930 27 7
KS006 2x20	2.00		20.00	5,230	2.50	1	986 92 4
KS006 2x25	2.00		25.00	100	0.06	200	930 79 5
KS006 2x25	2.00		25.00	1,675	1.00	25	930 28 5
KS006 2x25	2.00		25.00	4,177	2.50	1	986 88 7
KS006 2x30	2.00		30.00	100	0.07	200	930 80 8
KS006 2x30	2.00		30.00	1,395	1.00	25	930 29 3
KS006 2x30	2.00		30.00	3,488	2.50	1	986 86 0
KS006 2x40	2.00		40.00	100	0.10	120	930 82 4
KS006 2x40	2.00		40.00	1,046	1.00	25	930 31 4
KS006 2x40	2.00		40.00	2,615	2.50	1	986 82 8
KS006 2,5x16	2.50		16.00	1,370	1.00	25	937 36 4
KS006 2,5x20	2.50		20.00	1,326	1.00	25	937 37 2
KS006 2,5x25	2.50		25.00	100	0.09	200	930 83 2
KS006 2,5x25	2.50		25.00	1,062	1.00	25	930 32 2
KS006 2,5x30	2.50		30.00	100	0.11	200	930 84 0
KS006 2,5x30	2.50		30.00	884	1.00	25	930 33 0
KS006 2,5x30	2.50		30.00	2,210	2.50	1	986 72 1
KS006 2,5x35	2.50		35.00	100	0.13	200	930 85 9
KS006 2,5x40	2.50		40.00	100	0.15	120	930 86 7
KS006 2,5x40	2.50		40.00	663	1.00	25	930 35 7
KS006 2,5x40	2.50		40.00	1,325	2.50	1	986 68 4
KS006 2,5x50	2.50		50.00	100	0.19	80	930 88 3
KS006 2,5x50	2.50		50.00	530	1.00	25	930 37 3
KS125 2,5x60	2.50		60.00	442	1.00	25	930 38 1
KS125 2,5x70	2.50		70.00	379	1.00	25	939 12 4
KS006 3x30	3.00		30.00	633	1.00	25	930 41 0
KS006 3x30	3.00		30.00	100	0.16	200	930 91 2
KS006 3x30	3.00		30.00	1,583	2.50	1	986 52 9
KS006 3x40	3.00		40.00	474	1.00	25	930 43 7
KS006 3x40	3.00		40.00	100	0.21	120	930 93 9
KS006 3x40	3.00		40.00	1,185	2.50	1	986 47 3
KS006 3x50	3.00		50.00	380	1.00	25	930 45 3
KS006 3x50	3.00		50.00	100	0.26	80	930 95 5
KS006 3x50	3.00		50.00	950	2.50	1	986 44 9
KS006 3x60	3.00		60.00	316	1.00	25	930 46 1
KS006 3x60	3.00		60.00	100	0.32	70	930 96 3
KS006 3x60	3.00		60.00	790	2.50	1	986 42 2
KS006 3x70	3.00		70.00	100	0.37	70	938 50 0
KS006 3,4x50	3.40		50.00	100	0.36	70	986 29 3
KS006 3,4x60	3.40		60.00	100	0.44	70	986 29 7
KS006 3,4x70	3.40		70.00	100	0.51	70	986 25 4
KS006 3,4x80	3.40		80.00	100	0.58	70	986 23 8
KS006 4,2x90	4.20		90.00	100	0.89	40	986 07 8

Steel nail, smooth, countersunk head (KS111)

To fasten hard or soft wood in concrete or stone.

Steel, Hardened Electrogalvanised



Type	Shank Ø mm	Nail length mm	Contents	Weight	Shipping	Item No.
			PU pcs	kg/PU	box PU	
KS111 2x20	2.00	20.00	100	0.05	200	944 84 7
KS111 2x25	2.00	25.00	100	0.06	200	944 78 3
KS111 2x30	2.00	30.00	100	0.07	200	944 89 8
KS111 2,5x16	2.50	16.00	1,659	1.00	25	949 49 6
KS111 2,5x18	2.50	18.00	1,659	1.00	25	949 45 3
KS111 2,5x20	2.50	20.00	1,326	1.00	25	949 48 8
KS111 2,5x25	2.50	25.00	100	0.10	200	939 42 3
KS111 2,5x30	2.50	30.00	100	0.11	200	939 43 1
KS111 2,5x30	2.50	30.00	884	1.00	25	949 50 9
KS111 2,5x35	2.50	35.00	100	0.13	200	939 45 8
KS111 2,5x40	2.50	40.00	100	0.15	120	939 46 6
KS111 2,5x40	2.50	40.00	649	1.00	25	949 53 3
KS111 2,5x45	2.50	45.00	100	0.17	80	939 47 4
KS111 2,5x50	2.50	50.00	100	0.19	70	933 32 4
KS111 2,5x50	2.50	50.00	100	0.19	80	939 48 2
KS111 2,5x50	2.50	50.00	530	1.00	25	949 54 1
KS171 2,5x60	2.50	60.00	100	0.23	70	939 49 0
KS171 2,5x70	2.50	70.00	100	0.26	70	939 50 3
KS111 3x25	3.00	25.00	100	0.13	200	939 16 7
KS111 3x30	3.00	30.00	100	0.16	90	933 32 9
KS111 3x30	3.00	30.00	100	0.16	200	939 17 5
KS111 3x35	3.00	35.00	100	0.18	200	939 18 3
KS111 3x40	3.00	40.00	100	0.21	90	933 33 3
KS111 3x40	3.00	40.00	100	0.21	120	939 19 1
KS111 3x40	3.00	40.00	474	1.00	25	949 64 8
KS111 3x45	3.00	45.00	100	0.24	80	939 20 4
KS111 3x50	3.00	50.00	100	0.27	70	933 33 6
KS111 3x50	3.00	50.00	100	0.27	80	939 21 2
KS111 3x50	3.00	50.00	370	1.00	25	949 65 6
KS111 3x60	3.00	60.00	100	0.32	70	939 22 0
KS111 3x60	3.00	60.00	316	1.00	25	949 66 4
KS111 3x65	3.00	65.00	100	0.34	70	939 23 9
KS111 3x70	3.00	70.00	100	0.37	70	939 24 7
KS111 3x70	3.00	70.00	271	1.00	25	965 18 9
KS111 3x75	3.00	75.00	100	0.40	70	939 25 5
KS111 3,4x25	3.40	25.00	100	0.18	200	992 49 0
KS111 3,4x25	3.40	25.00	553	1.00	1	949 67 1
KS111 3,4x35	3.40	35.00	100	0.25	80	992 49 4
KS111 3,4x35	3.40	35.00	395	1.00	1	949 67 5
KS111 3,4x40	3.40	40.00	100	0.29	80	994 41 8
KS111 3,4x45	3.40	45.00	100	0.33	80	992 35 5
KS111 3,4x50	3.40	50.00	100	0.36	70	983 00 2
KS111 3,4x55	3.40	55.00	100	0.40	70	992 36 3
KS111 3,4x60	3.40	60.00	100	0.45	70	983 01 0
KS111 3,4x60	3.40	60.00	225	1.00	1	949 73 8
KS111 3,4x65	3.40	65.00	100	0.47	70	992 37 1
KS111 3,4x70	3.40	70.00	100	0.52	70	939 51 1
KS111 3,4x80	3.40	80.00	100	0.58	70	973 06 6
KS171 3,4x100	3.40	100.00	100	0.73	40	939 27 5
KS111 3,5x40	3.50	40.00	344	1.00	25	949 68 0
KS111 3,5x50	3.50	50.00	275	1.00	25	949 69 9
KS111 3,5x60	3.50	60.00	225	1.00	25	949 73 6
KS111 3,5x70	3.50	70.00	193	1.00	25	949 74 4
KS111 4,2x60	4.20	60.00	100	0.59	40	992 32 0
KS111 4,2x70	4.20	70.00	100	0.69	40	992 33 9
KS111 4,2x80	4.20	80.00	100	0.78	40	992 34 7
KS111 4,2x90	4.20	90.00	100	0.89	40	992 41 9
KS111 4,2x100	4.20	100.00	100	0.98	40	973 17 0

Steel nail

Steel nail, smooth, countersunk head, ballistic head, galvanised (KS148)

To fasten hard or soft wood in concrete or stone.

Steel, Hardened Galvanised



Type	Shank Ø	Nail length		Contents PU pcs	Weight kg/PU	Shipping box PU	Item No.
		mm	mm				
KS148 2,5x30	2.50	30.00		100	0.11	200	964 20 7
KS148 2,5x30	2.50	30.00		250	0.28	40	964 41 8
KS148 2,5x40	2.50	40.00		100	0.15	120	964 21 5
KS148 2,5x40	2.50	40.00		250	0.38	40	964 42 6
KS148 2,5x50	2.50	50.00		100	0.19	80	964 22 3
KS148 2,5x50	2.50	50.00		250	0.47	40	964 43 4
KS148 3x30	3.00	30.00		250	0.40	70	964 44 2
KS148 3x40	3.00	40.00		100	0.21	120	964 25 8
KS148 3x40	3.00	40.00		250	0.53	40	964 45 0
KS148 3x50	3.00	50.00		100	0.26	70	964 26 6
KS148 3x50	3.00	50.00		250	0.66	40	964 46 9
KS148 3x60	3.00	60.00		100	0.32	70	964 27 4
KS148 3x60	3.00	60.00		250	0.79	40	964 47 7

CHARACTERISTIC:

- Manufactured from special electric steel with a high carbon content
- Hardened and annealed on modern, fully automatic production lines in a continuous process under strict quality control
- Corrosion protection: Electrogalvanised
- High-hardness steel nails, coupled with an extremely high tensile and break resistance to ensure absolute safety during work
- The fluted shank increases the extraction value

Steel nail, fluted, countersunk head (KS153/KS002)

To fasten hard or soft wood in concrete or stone.

Steel, Hardened Electrogalvanised

Type	Shank Ø mm	Nail length mm	Contents PU pcs	Weight kg/PU	Shipping box PU	Item No.
KS153 2,7x20	2.70	20.00	1,316	1.00	25	956 70 9
KS153 2,7x20	2.70	20.00	250	0.19	120	956 60 2
KS153 2,7x25	2.70	25.00	250	0.24	120	956 61 0
KS153 2,7x25	2.70	25.00	1,062	1.00	25	956 71 7
KS153 2,7x30	2.70	30.00	250	0.30	120	956 62 9
KS153 2,7x30	2.70	30.00	826	1.00	25	956 72 5
KS002 2,7x35	2.70	35.00	250	0.33	40	983 72 3
KS002 2,7x35	2.70	35.00	752	1.00	25	931 91 5
KS002 2,7x40	2.70	40.00	658	1.00	25	931 92 3
KS002 2,7x40	2.70	40.00	250	0.38	40	983 70 7
KS002 2,7x50	2.70	50.00	526	1.00	25	931 93 1
KS002 2,7x50	2.70	50.00	250	0.48	40	983 68 6
KS002 2,7x60	2.70	60.00	439	1.00	25	931 95 8
KS002 2,7x60	2.70	60.00	250	0.57	40	983 65 1
KS002 2,7x70	2.70	70.00	376	1.00	25	931 96 6
KS002 2,7x70	2.70	70.00	250	0.67	40	983 63 5
KS002 3,5x30	3.50	30.00	457	1.00	25	931 97 4
KS002 3,5x30	3.50	30.00	250	0.55	40	983 61 9
KS002 3,5x35	3.50	35.00	250	0.64	40	943 20 3
KS002 3,5x35	3.50	35.00	391	1.00	25	983 59 8
KS002 3,5x40	3.50	40.00	342	1.00	25	931 99 0
KS002 3,5x40	3.50	40.00	250	0.73	40	983 56 3
KS002 3,5x45	3.50	45.00	304	1.00	25	932 08 8
KS002 3,5x45	3.50	45.00	250	0.82	40	983 54 7
KS002 3,5x50	3.50	50.00	274	1.00	25	932 09 6
KS002 3,5x50	3.50	50.00	250	0.91	40	983 52 0
KS002 3,5x55	3.50	55.00	249	1.00	25	932 11 0
KS002 3,5x55	3.50	55.00	250	1.00	40	983 50 4
KS002 3,5x60	3.50	60.00	224	1.00	25	932 11 7
KS002 3,5x60	3.50	60.00	250	1.12	40	983 48 3
KS002 3,5x65	3.50	65.00	210	1.00	25	932 12 5
KS002 3,5x65	3.50	65.00	250	1.19	40	983 46 7
KS002 3,5x70	3.50	70.00	195	1.00	25	932 13 3
KS002 3,5x70	3.50	70.00	250	1.28	16	983 44 0
KS002 3,5x75	3.50	75.00	250	1.43	16	983 42 4
KS002 3,5x80	3.50	80.00	171	1.00	25	932 16 8
KS002 3,5x80	3.50	80.00	250	1.46	16	983 40 8
KS002 4,5x30	4.50	30.00	250	0.74	40	983 38 7
KS002 4,5x40	4.50	40.00	250	0.98	40	983 36 0
KS002 4,5x50	4.50	50.00	204	1.00	25	932 17 6
KS002 4,5x50	4.50	50.00	250	1.23	40	983 34 4
KS002 4,5x55	4.50	55.00	250	1.34	40	983 32 8
KS002 4,5x60	4.50	60.00	170	1.00	25	932 18 4
KS002 4,5x60	4.50	60.00	250	1.47	16	983 29 9
KS002 4,5x65	4.50	65.00	250	1.59	16	983 27 2
KS002 4,5x70	4.50	70.00	146	1.00	25	932 19 2
KS002 4,5x70	4.50	70.00	250	1.71	16	983 25 6
KS002 4,5x80	4.50	80.00	128	1.00	25	932 20 5
KS002 4,5x80	4.50	80.00	250	1.95	16	983 22 1
KS002 4,5x90	4.50	90.00	113	1.00	25	932 21 3
KS002 4,5x90	4.50	90.00	250	2.20	16	983 20 5
KS002 4,5x100	4.50	100.00	102	1.00	25	932 22 1
KS002 4,5x100	4.50	100.00	250	2.60	16	983 18 4



Steel nail, fluted

Steel nail, continuously fluted, disc head (KS112)

To fasten roof, insulation plates and expanded metal on concrete or masonry.

Steel, Hardened Electrogalvanised



Type	Shank Ø		Nail length		Contents PU pcs	Weight kg/PU	Shipping box PU	Item No.
	mm	mm	mm	mm				
KS112 3,5x20	3.50		20.00		250	0.68	25	980 42 6
KS112 3,5x25	3.50		25.00		250	0.79	25	972 92 8
KS112 3,5x30	3.50		30.00		250	0.86	25	944 51 5
KS112 3,5x35	3.50		35.00		250	0.96	12	972 94 4
KS112 3,5x40	3.50		40.00		250	1.06	12	972 71 1
KS112 3,5x50	3.50		50.00		250	1.24	12	972 71 3
KS112 3,5x60	3.50		60.00		250	1.41	12	972 71 5
KS112 3,5x70	3.50		70.00		250	1.56	12	972 71 7
KS112 3,5x80	3.50		80.00		250	1.74	12	972 71 9
KS112 3,5x100	3.50		100.00		125	1.05	12	972 72 1

CHARACTERISTIC:

- For (almost) invisible fastening
- The thin pin with its small head is ideal for fastening skirting boards or connecting frames without the nail being visible

Selvedge pin, smooth, compression head, blue annealed (KS076/KS085)

To fasten skirting boards and picture frames.

Steel, Hardened Bright

Type	Shank Ø mm	Nail length mm	Contents	Weight	Shipping	Item No.
			PU pcs	kg/PU	box PU	
KS076 1,5x20	1.50	20.00	3,293	1.00	25	972 69 6
KS076 1,5x25	1.50	25.00	2,634	1.00	25	938 24 4
KS076 1,5x30	1.50	30.00	2,195	1.00	25	938 25 2
KS085 1,5x35	1.50	35.00	1,882	1.00	25	949 70 1
KS085 1,5x40	1.50	40.00	1,646	1.00	25	949 75 2
KS085 1,5x45	1.50	45.00	1,463	1.00	25	949 72 8
KS076 2x30	2.00	30.00	1,392	1.00	25	940 83 8
KS076 2x35	2.00	35.00	1,194	1.00	25	969 52 6
KS076 2x40	2.00	40.00	1,044	1.00	25	938 29 5



Selvedge pin, smooth, compression head (KS150/KS151)

To fasten skirting boards and picture frames.

Steel, Hardened Electrogalvanised

Type	Shank Ø mm	Nail length mm	Contents	Weight	Shipping	Item No.
			PU pcs	kg/PU	box PU	
KS150 1,5x20	1.50	20.00	100	0.03	200	992 75 0
KS150 1,5x25	1.50	25.00	100	0.04	200	967 20 5
KS150 1,5x25	1.50	25.00	2,634	1.00	25	989 04 0
KS150 1,5x30	1.50	30.00	2,195	1.00	25	989 04 2
KS150 1,5x30	1.50	30.00	100	0.05	200	992 75 1
KS151 1,5x35	1.50	35.00	100	0.05	200	973 88 3
KS151 1,5x35	1.50	35.00	1,882	1.00	25	989 05 0
KS151 1,5x40	1.50	40.00	1,646	1.00	25	989 05 2
KS151 1,5x45	1.50	45.00	100	0.07	120	973 86 7
KS151 1,5x45	1.50	45.00	1,463	1.00	25	989 05 4



Shot nail/ hand-held nail

Shot nail, shot head and disc, mechanical galvanised (KG001)

To fasten clamps, metal strips on concrete and steel substrates.

Steel, Hardened Galvanised



Type	Shank Ø mm	Nail length mm	Contents	Weight	Shipping	Item No.
			PU pcs	kg/PU	box PU	
KG001 3,75x22	3.75	22.00	100	0.31	40	962 80 7
KG001 3,75x27	3.75	27.00	100	0.35	40	961 81 5
KG001 3,75x32	3.75	32.00	100	0.39	40	961 82 3
KG001 3,75x37	3.75	37.00	100	0.44	40	961 83 1
KG001 3,75x42	3.75	42.00	100	0.48	40	961 85 8
KG001 3,75x47	3.75	47.00	100	0.52	40	961 86 6
KG001 3,75x54	3.75	54.00	100	0.59	40	961 87 4
KG001 3,75x62	3.75	62.00	100	0.65	40	961 88 2
KG001 3,75x72	3.75	72.00	50	0.37	40	961 88 9
KG001 3,75x82	3.75	82.00	50	0.41	40	961 92 0
KG001 3,75x97	3.75	97.00	50	0.46	40	961 92 2

Hand-held nail, rounded head and disc, glossy-galvanised (KG003)

To fasten metal and plastic cable ducts.

Steel, Hardened Electro-galvanised



Type	Shank Ø mm	Nail length mm	Contents	Weight	Shipping	Item No.
			PU pcs	kg/PU	box PU	
KG003 2,5x25	2.50	25.00	200	0.31	50	953 03 7
KG003 2,5x30	2.50	30.00	200	0.33	50	953 03 6

Steel wall hook nail, smooth, square, blue annealed (KS132)

To fasten pipes, cables and frames.

Steel, Hardened Bright

Type	Shank Ø	Nail length mm	Contents	Weight	Shipping	Item No.
			PU	kg/PU	box	
	mm	mm	pcs		PU	
KS132 2x40	2.00	40.00	802	1.00	1	928 33 7
KS132 3x30	3.00	30.00	100	0.19	70	928 37 5
KS132 3x50	3.00	50.00	100	0.28	70	928 38 5
KS132 3x60	3.00	60.00	100	0.33	40	928 39 3
KS132 4x50	4.00	50.00	100	0.60	40	928 42 0
KS132 4x50	4.00	50.00	100	0.69	40	928 42 2
KS132 4x80	4.00	80.00	100	0.89	40	994 41 3
KS132 4x70	4.00	70.00	100	0.79	40	994 41 4
KS132 4x100	4.00	100.00	100	1.08	40	994 41 5



Hook nail, smooth, round, unhardened (B058)

To fasten pipes, cables and frames.

Steel, Unhardened Bright

Type	Shank Ø	Nail length mm	Contents	Weight	Shipping	Item No.
			PU	kg/PU	box	
	mm	mm	pcs		PU	
B058 3,0x30	3.00	30.00	250	0.46	25	917 92 8
B058 3,0x50	3.00	50.00	250	0.70	25	917 92 9
B058 3,0x50	3.00	50.00	250	0.83	25	917 93 0
B058 3,0x60	3.00	60.00	250	1.00	12	917 93 1
B058 3,0x70	3.00	70.00	250	1.15	12	917 93 2
B058 3,4x50	3.40	50.00	250	1.13	12	917 93 3
B058 3,4x60	3.40	60.00	250	1.23	12	917 93 4
B058 3,4x70	3.40	70.00	250	1.53	12	917 93 5
B058 3,4x80	3.40	80.00	100	0.68	12	917 93 6
B058 3,4x90	3.40	90.00	100	0.75	12	917 93 7
B058 3,4x100	3.40	100.00	100	0.82	12	917 93 8



Hook nail, smooth, round (B059)

To fasten pipes, cables and frames.

Steel, Unhardened Electrogalvanised

Type	Shank Ø	Nail length mm	Contents	Weight	Shipping	Item No.
			PU	kg/PU	box	
	mm	mm	pcs		PU	
B059 3x40	3.00	40.00	250	0.78	25	927 67 0
B059 3x50	3.00	50.00	250	0.91	25	927 67 2
B059 3x60	3.00	60.00	250	1.04	12	927 67 4
B059 3x70	3.00	70.00	250	1.17	12	927 67 6
B059 3,4x40	3.40	40.00	250	1.00	25	927 66 6
B059 3,4x50	3.40	50.00	250	1.18	25	927 66 7
B059 3,4x70	3.40	70.00	250	1.54	12	927 66 9
B059 3,4x80	3.40	80.00	100	0.68	12	927 67 1



Hook nail

Hook nail, fluted, round (KS138)

To fasten pipes, cables and frames.

Steel, Hardened Electrogalvanised



Type	Shank Ø mm	Nail length mm	Contents	Weight	Shipping	Item No.
			PU pcs	kg/PU	box PU	
KS138 4x40	4.00	40.00	100	0.51	40	927 53 5
KS138 4x50	4.00	50.00	100	0.45	40	927 53 7
KS138 4x60	4.00	60.00	100	0.56	40	927 53 9
KS138 4x75	4.00	75.00	100	0.66	40	927 54 5

CHARACTERISTIC:

- Hardened steel nail for fastening in concrete.
- Vulcanised fibre disc prevents cable damage
- Two versions: Blue annealed or glossy-galvanised
- 10 plastic bags each with 100 pieces in a packaging unit (PU)

Impu steel nail, blue annealed (KG010)

To fasten ribbon conductors.

Steel, Hardened Bright

Type	Shank Ø	Nail length	Contents	Weight	Shipping	Item No.
			PU	kg/PU	box	
	mm	mm	pcs		PU	
KG010 2x12	2.00	12.00	1,000	0.40	20	904 45 9
KG010 2x16	2.00	16.00	1,000	0.49	20	904 46 0
KG010 2x18	2.00	18.00	1,000	0.55	20	904 46 1
KG010 2x23	2.00	23.00	1,000	0.62	10	904 46 2
KG010 2x30	2.00	30.00	1,000	0.81	10	904 46 3
KG010 2x40	2.00	40.00	1,000	1.08	12	904 46 4
KG010 2x50	2.00	50.00	1,000	1.28	9	904 46 5
KG010 2x60	2.00	60.00	1,000	1.15	9	904 46 6



Impu steel nail (KG011)

To fasten ribbon conductors.

Steel, Hardened Electrogalvanised

Type	Shank Ø	Nail length	Contents	Weight	Shipping	Item No.
			PU	kg/PU	box	
	mm	mm	pcs		PU	
KG011 2x12	2.00	12.00	1,000	0.40	20	904 46 7
KG011 2x16	2.00	16.00	1,000	0.46	20	904 46 8
KG011 2x18	2.00	18.00	1,000	0.58	20	904 46 9
KG011 2x23	2.00	23.00	1,000	0.68	10	904 47 0
KG011 2x30	2.00	30.00	1,000	0.85	10	904 47 1
KG011 2x40	2.00	40.00	1,000	1.08	12	904 47 2
KG011 2x50	2.00	50.00	1,000	1.28	9	904 47 3
KG011 2x60	2.00	60.00	1,000	1.50	9	904 47 4



Siku nail

CHARACTERISTIC:

- Hardened steel nail for fastening in concrete
- With polyethylene protective coating to protect the fastened cables
- Two versions: Blue annealed or glossy-galvanised
- 10 plastic bags each with 100 pieces in a packaging unit (PU)



Siku nail, blue annealed (KG012)

To fasten ribbon conductors.

Steel, Hardened Bright

Type	Shank Ø		Nail length mm	Contents PU pcs	Weight kg/PU	Shipping box PU	Item No.
	mm	mm					
KG012 2x12	2.00	12.00		1,000	0.42	20	904 47 5
KG012 2x16	2.00	16.00		1,000	0.49	20	904 47 6
KG012 2x18	2.00	18.00		1,000	0.52	20	904 47 7
KG012 2x23	2.00	23.00		1,000	0.64	10	904 47 8
KG012 2x30	2.00	30.00		1,000	0.81	10	904 47 9
KG012 2x40	2.00	40.00		1,000	1.04	12	904 48 0
KG012 2x50	2.00	50.00		1,000	1.34	8	904 48 1
KG012 2x60	2.00	60.00		1,000	1.54	9	904 48 2



Siku nail (KG013)

To fasten ribbon conductors.

Steel, Hardened Electrogalvanised

Type	Shank Ø		Nail length mm	Contents PU pcs	Weight kg/PU	Shipping box PU	Item No.
	mm	mm					
KG013 2x12	2.00	12.00		1,000	0.42	20	904 48 3
KG013 2x16	2.00	16.00		1,000	0.49	20	904 48 4
KG013 2x18	2.00	18.00		1,000	0.52	20	904 48 5
KG013 2x23	2.00	23.00		1,000	0.64	10	904 48 6
KG013 2x30	2.00	30.00		1,000	0.81	10	904 48 7
KG013 2x40	2.00	40.00		1,000	1.04	12	904 48 8
KG013 2x50	2.00	50.00		1,000	1.54	8	904 48 9

CHARACTERISTIC:

- The diameter given is measured on the profile

Screw nail, 60° thread (PR089)

To fasten wood connectors.

Steel, Hardened Electrogalvanised

Type	Shank Ø mm	Nail length mm	Contents PU pcs	Weight kg/PU	Shipping box PU	Item No.
PR189 3,4x35	3.40	35.00	250	0.45	1	993 48 9
PR189 3,4x40	3.40	40.00	250	0.51	1	994 58 8
PR189 3,4x45	3.40	45.00	250	0.58	1	993 58 5
PR189 3,4x50	3.40	50.00	250	0.64	1	994 59 6
PR189 3,4x60	3.40	60.00	250	0.78	1	993 61 4
PR189 3,4x65	3.40	65.00	250	0.85	1	997 93 0
PR189 4x80	4.00	80.00	250	1.55	1	993 68 1
PR189 4x70	4.00	70.00	250	1.35	1	993 65 7
PR189 4,5x100	4.50	100.00	250	2.32	1	994 51 0
PR189 4,8x90	4.80	90.00	250	2.10	1	994 50 2



Screw nail, 65° thread (PR155)

To fasten wood connectors.

Steel, Hardened Electrogalvanised

Type	Shank Ø mm	Nail length mm	Contents PU pcs	Weight kg/PU	Shipping box PU	Item No.
PR155 3,8x32	3.80	32.00	1,000	2.12	1	948 47 7
PR155 3,8x40	3.80	40.00	1,000	2.58	1	962 42 0
PR155 3,8x60	3.80	60.00	500	1.98	1	971 88 8



Wire nail, brass

CHARACTERISTIC:

- Compression head: Head can be lowered completely into the substrate
- Rounded head: Attractive completion for visible fastenings, wide support surface
- Large flat head: Prevents damage to the fastening material, high contact pressure thanks to the increased support area



Wire nail, flat rounded head (ME004)

To fasten, for example, picture frames or panels on soft substrates.

Brass

Type	Shank Ø		Nail length mm	Contents PU pcs	Weight kg/PU	Shipping box PU	Item No.
	mm	mm					
ME004 1x10	1.00	10.00		16,660	1.00	25	983 76 6
ME004 1x15	1.00	15.00		11,096	1.00	25	983 78 2
ME004 1,2x15,5	1.20	15.50		6,369	1.00	25	983 81 1
ME004 1,2x20	1.20	20.00		4,782	1.00	25	983 84 6
ME004 1,5x20	1.50	20.00		2,700	1.00	25	983 88 9
ME004 1,5x25	1.50	25.00		2,161	1.00	25	983 91 8
ME004 1,6x25	1.60	25.00		2,161	1.00	25	983 93 4
ME004 1,8x30	1.80	30.00		1,323	1.00	25	983 97 7
ME004 2x40	2.00	40.00		826	1.00	25	984 01 3
ME004 2,4x45	2.40	45.00		513	1.00	25	984 04 8
ME004 2,7x50	2.70	50.00		383	1.00	25	984 06 4
ME004 2,7x55	2.70	55.00		348	1.00	25	984 08 0
ME004 3x65	3.00	65.00		238	1.00	25	984 10 1



Wire nail, compression head (ME003)

To fasten, for example, picture frames or panels on soft substrates.

Brass

Type	Shank Ø		Nail length mm	Contents PU pcs	Weight kg/PU	Shipping box PU	Item No.
	mm	mm					
ME003 1,2x20	1.20	20.00		4,782	1.00	25	983 51 2
ME003 1,5x20	1.50	20.00		2,700	1.00	25	983 55 5
ME003 1,5x25	1.50	25.00		2,161	1.00	25	983 57 1
ME003 1,6x25	1.60	25.00		2,161	1.00	25	983 60 0
ME003 1,8x30	1.80	30.00		1,323	1.00	25	983 62 7
ME003 2x40	2.00	40.00		826	1.00	25	983 67 8
ME003 2,4x45	2.40	45.00		513	1.00	25	983 69 4
ME003 2,7x50	2.70	50.00		383	1.00	25	983 71 5

Wire nail, flat head, embossed (ME002)

To fasten, for example, picture frames or panels on soft substrates.

Brass

Type	Shank Ø		Nail length		Contents PU pcs	Weight kg/PU	Shipping box PU	Item No.
	mm	mm	mm	mm				
ME002 1,5x20	1.50		20.00		2,700	1.00	25	983 24 8
ME002 1,6x25	1.60		25.00		2,161	1.00	25	983 28 0
ME002 1,8x30	1.80		30.00		1,323	1.00	25	983 30 1
ME002 2,7x50	2.70		50.00		383	1.00	25	983 39 5



Wire nail, stainless steel

CHARACTERISTIC:

- Stainless steel, rustproof 1.4401, is suitable for outdoor use
- The fluting and the re-hooking profile produces a very high extraction force



Screw nail, rounded head V2A [AISI 304] (ZZ023)

To fasten wood in protected outdoor areas.
Stainless steel, grade 304

Type	Shank Ø mm	Nail length mm	Contents PU pcs	Weight kg/PU	Shipping box PU	Item No.
ZZ023 2,5x25	2.50	25.00	1,024	1.00	1	970 27 9
ZZ023 2,9x50	2.90	50.00	394	1.00	1	970 30 8



Wire nail, flat rounded head V2A [AISI304] (RV001)

To fasten wood in protected outdoor areas.
Stainless steel, grade 304

Type	Shank Ø mm	Nail length mm	Contents PU pcs	Weight kg/PU	Shipping box PU	Item No.
RV001 1,6x20	1.60	20.00	2,857	1.00	25	967 67 8
RV001 1,6x25	1.60	25.00	2,250	1.00	25	997 95 7
RV001 1,8x32	1.80	32.00	1,493	1.00	25	997 60 7
ZZ008 3x65	3.00	65.00	280	1.00	25	941 52 3
ZZ019 3,4x65	3.40	65.00	214	1.00	25	973 07 4
ZZ008 3,4x65	3.40	65.00	215	1.00	25	977 74 5
ZZ016 3,4x65	3.40	65.00	212	1.00	25	995 12 6
ZZ016 3,4x80	3.40	80.00	172	1.00	25	971 11 6
ZZ019 3,4x80	3.40	80.00	172	1.00	25	973 08 2
ZZ008 3,4x80	3.40	80.00	172	1.00	25	977 72 9



Selvedge pin, compression head, V2A [AISI304] (RV014)

To fasten wood in protected outdoor areas.
Stainless steel, grade 304

Type	Shank Ø mm	Nail length mm	Contents PU pcs	Weight kg/PU	Shipping box PU	Item No.
RV014 1,6x20	1.60	20.00	2,857	1.00	25	973 09 0
RV014 1,6x25	1.80	25.00	2,381	1.00	25	973 10 3
RV014 1,8x32	1.80	32.00	1,493	1.00	25	967 46 7
RV014 2,1x40	2.10	40.00	943	1.00	25	967 47 5
RV014 2,4x45	2.40	45.00	637	1.00	25	967 48 3
RV014 2,8x50	2.80	50.00	418	1.00	25	967 49 1
RV014 2,8x55	2.80	55.00	380	1.00	25	973 23 4

Wire nail, flat head V2A [AISI304] (RV013)

To fasten wood in protected outdoor areas.

Stainless steel, grade 304

Type	Shank Ø		Nail length mm	Contents PU pcs	Weight kg/PU	Shipping box PU	Item No.
	mm	mm					
RV013 1,6x20	1.60		20.00	2,857	1.00	25	967 30 1
RV013 1,6x25	1.60		25.00	2,381	1.00	25	967 32 8



Grooved nail with plastic head V4A [AISI316] (RV038)

For outdoor fastening of wood in windowsills, boat or ship construction, etc.

Stainless steel, grade 316

Type	Shank Ø		Nail length mm	Contents PU pcs	Weight kg/PU	Shipping box PU	Item No.
	mm	mm					
RV038 2x30	2.00		30.00	500	0.41	10	973 40 0
RV038 2x30	2.00		30.00	100	0.08	50	973 41 5
RV038 2x40	2.00		40.00	500	0.54	10	973 40 1
RV038 2x40	2.00		40.00	100	0.11	50	973 41 7
RV038 2,65x50	2.65		50.00	100	0.23	50	973 43 0
RV038 2,65x50	2.65		50.00	500	1.16	10	973 41 0
RV038 3,35x65	3.35		65.00	200	1.00	10	973 26 6



Wire nail, stainless steel, according to construction products ordinance

CHARACTERISTIC:

- Stainless steel is suitable for outdoor use
- The fluting and the re-hooking profile produces a very high extraction force
- Articles are labelled according to the construction products ordinance 305/2011 CE



Wire nail, rounded head V2A [AISI304] according to construction products ordinance (RV001)

To fasten wood in protected outdoor areas.

Stainless steel, grade 304

Type	Shank Ø mm	Nail length mm	Contents PU pcs	Weight kg/PU	Shipping box PU	Item No.
RV001 2,1x40	2.10	40.00	943	1.00	25	997 62 3
RV001 2,4x45	2.40	45.00	637	1.00	25	997 63 1
RV001 2,8x50	2.80	50.00	418	1.00	25	997 67 4
RV001 2,8x55	2.80	55.00	380	1.00	25	997 68 2



Wire nail, flat head V2A [AISI304] according to construction products ordinance (RV013)

To fasten wood in protected outdoor areas.

Stainless steel, grade 304

Type	Shank Ø mm	Nail length mm	Contents PU pcs	Weight kg/PU	Shipping box PU	Item No.
RV013 2,1x40	2.10	40.00	943	1.00	25	967 34 4
RV013 2,8x50	2.80	50.00	418	1.00	25	967 45 9
RV013 2,8x55	2.80	55.00	380	1.00	25	967 36 0



Grooved nail, half rounded head V2A [AISI304] according to construction products ordinance (RV034)

To fasten wood in protected outdoor areas.

Stainless steel, grade 304

Type	Shank Ø mm	Nail length mm	Contents PU pcs	Weight kg/PU	Shipping box PU	Item No.
RV034 1,9x25	1.90	25.00	1,759	1.00	10	973 24 0
RV034 1,9x30	1.90	30.00	1,525	1.00	10	973 24 2
RV034 1,9x35	1.90	35.00	1,300	1.00	10	973 24 4
RV034 2,4x35	2.40	35.00	727	1.00	10	973 25 0
RV034 2,4x45	2.40	45.00	566	1.00	10	973 25 4
RV034 2,4x50	2.40	50.00	522	1.00	10	973 25 3
RV034 2,4x60	2.40	60.00	418	1.00	10	973 25 5
RV034 3,1x50	3.10	50.00	308	1.00	10	973 26 0
RV034 3,1x60	3.10	60.00	270	1.00	10	973 26 4
RV034 3,1x75	3.10	75.00	211	1.00	10	973 26 8

Wire nail, stainless steel, according to construction products

Grooved nail, half rounded head V4A [AISI316] according to construction products ordinance (RV037)

For outdoor fastening of wood in windowsills, boat or ship construction, etc.

Stainless steel, grade 316

Type	Shank Ø mm	Nail length mm	Contents	Weight	Shipping	Item No.
			PU pcs	kg/PU	box PU	
RV037 1,9x30	1.90	30.00	1,453	1.00	10	973 27 2
RV037 1,9x35	1.90	35.00	1,260	1.00	10	973 27 4
RV037 2,4x45	2.40	45.00	566	1.00	10	973 27 8
RV037 2,4x50	2.40	50.00	490	1.00	10	973 28 0
RV037 2,4x60	2.40	60.00	418	1.00	10	973 28 4
RV037 3,1x75	3.10	75.00	211	1.00	10	973 29 0



Nail anchor

CHARACTERISTIC:

- Nail ties can be used without anchors

INSTRUCTIONS FOR USE:

- Drill the hole according to the diameter of the nail anchor and 5 mm deeper than the length of the anchor
- Then simply knock into the hole



Nail tie, half rounded head, small NAS (KS198)

For quick and easy fastening in sandstone and concrete.

Steel, Hardened Electrogalvanised

Type	Shank Ø		Contents PU	Weight kg/PU	Shipping box PU	Item No.
	mm	mm				
NAS 4x40	4.00	40.00	100	0.39	40	950 10 2
NAS 4x50	4.00	50.00	100	0.49	40	950 10 4
NAS 4x60	4.00	60.00	100	0.59	40	950 10 6



Nail tie, half rounded head, large NAB (KS186)

For quick and easy fastening in sandstone and concrete.

Steel, Hardened Electrogalvanised

Type	Shank Ø		Contents PU	Weight kg/PU	Shipping box PU	Item No.
	mm	mm				
NAB 5x30	5.00	30.00	100	0.50	40	950 12 0
NAB 5x40	5.00	40.00	100	0.66	40	950 12 2
NAB 5x60	5.00	60.00	100	0.99	40	950 12 6

INSTRUCTIONS FOR USE:

- Drill a 4 mm hole through the slat into the concrete and knock in
- To release, knock the slat and the nail will break at the predetermined breaking point

Panel pin, coarse, countersunk head (KS209)

To fix panels on concrete.

Steel, Hardened Electrogalvanised

Type	Shank Ø	Nail length	Contents PU	Weight	Shipping box	Item No.
	mm	mm	pcs	kg/PU	PU	
KS209 4x40	4.00	40.00	100	0.39	25	949 71 4



Panel pin, countersunk head (KS258, KS259)

To fix panels on concrete.

Steel, Hardened Electrogalvanised

Type	Shank Ø	Nail length	Contents PU	Weight	Shipping box	Item No.
	mm	mm	pcs	kg/PU	PU	
KS258 4x40	4.00	40.00	100	0.43	25	949 71 9
KS259 4x50	4.00	50.00	100	0.54	25	949 72 0



Ceiling hook

CHARACTERISTIC:

- With wood screw thread approx. 20 mm
- Can also be used with anchors



100
St./Pcs.

Ceiling hook (SC019)

For universal use with anchors on the ceiling or wall or without anchors in wood.

Steel Electrogalvanised

Type	Diameter	Length	Contents PU	Weight	Shipping box	Item No.
	mm	mm	pcs	kg/PU	PU	
SC019 3,9x50	3.90	50.00	100	0.72	12	904 44 3
SC019 3,9x60	3.90	60.00	100	0.80	12	904 44 4
SC019 3,9x70	3.90	70.00	100	0.88	12	904 44 5
SC019 3,9x80	3.90	80.00	100	0.91	12	904 44 6

CHARACTERISTIC:

- Can also be used with anchors

Hex-head wood screw DIN 571 (SC018)

For universal use with anchors or without anchors in wood

Steel Electrogalvanised

Type	Diameter		Length	Contents PU pcs	Weight kg/PU	Shipping box PU	Item No.
	mm	mm					
SC018 6x40	6.00	40.00		50	0.83	24	904 42 7
SC018 6x50	6.00	50.00		50	0.96	20	904 42 8
SC018 6x60	6.00	60.00		50	1.12	20	904 42 9
SC018 6x80	6.00	80.00		50	1.38	18	904 43 0
SC018 8x40	8.00	40.00		50	1.56	6	904 43 1
SC018 8x50	8.00	50.00		50	1.82	6	904 43 2
SC018 8x60	8.00	60.00		50	2.10	12	904 43 3
SC018 8x70	8.00	70.00		50	2.36	12	904 43 4
SC018 8x80	8.00	80.00		50	2.65	12	904 43 5
SC018 8x100	8.00	100.00		50	3.20	6	904 43 6
SC018 10x60	10.00	60.00		25	3.65	12	904 43 7
SC018 10x70	10.00	70.00		25	4.05	10	904 43 8
SC018 10x80	10.00	80.00		25	4.51	12	904 43 9
SC018 10x100	10.00	100.00		25	5.40	10	904 44 0
SC018 12x70	12.00	70.00		20	5.75	12	904 44 1
SC018 12x80	12.00	80.00		20	6.43	12	904 44 2



Chipboard screw

CHARACTERISTIC:

- Chipboard screws for universal use
- Suitable for wood, chipboard, anchors



Chipboard screw, countersunk head with Philips head (SC015)

For universal use with anchors or without anchors in wood.

Steel Electrogalvanised, yellow passivated

Type	Diameter		Length	Contents PU pcs	Weight kg/PU	Shipping box PU	Item No.
	mm	mm					
SC015 3,5x25	3.50	25.00		200	0.14	30	904 34 6
SC015 3,5x30	3.50	30.00		200	0.18	30	904 34 7
SC015 3,5x35	3.50	35.00		200	0.24	20	904 34 8
SC015 3,5x40	3.50	40.00		200	0.42	16	904 34 9
SC015 3,5x45	3.50	45.00		200	0.44	16	904 35 0
SC015 3,5x50	3.50	50.00		200	0.48	16	904 35 1
SC015 4x25	4.00	25.00		200	0.25	30	904 35 2
SC015 4x30	4.00	30.00		200	0.44	20	904 35 3
SC015 4x35	4.00	35.00		200	0.50	16	904 35 4
SC015 4x40	4.00	40.00		200	0.48	16	904 35 5
SC015 4x45	4.00	45.00		200	0.56	16	904 35 6
SC015 4x50	4.00	50.00		200	0.62	12	904 35 7
SC015 4,5x30	4.50	30.00		200	0.58	20	904 35 8
SC015 4,5x35	4.50	35.00		200	0.60	16	904 35 9
SC015 4,5x40	4.50	40.00		200	0.62	16	904 36 0
SC015 4,5x45	4.50	45.00		200	0.70	16	904 36 1
SC015 4,5x50	4.50	50.00		200	0.80	12	904 36 2
SC015 5x30	5.00	30.00		200	0.80	16	904 36 3
SC015 5x35	5.00	35.00		200	0.83	16	904 36 4
SC015 5x40	5.00	40.00		200	0.91	16	904 36 5
SC015 5x45	5.00	45.00		200	0.59	12	904 36 6
SC015 5x50	5.00	50.00		200	0.92	12	904 36 7
SC015 6x40	6.00	40.00		200	1.42	12	904 36 8
SC015 6x50	6.00	50.00		200	1.66	12	904 36 9
SC015 6x60	6.00	60.00		200	1.92	12	904 37 0



Chipboard screw, panhead with combination Philips head (SC016)

For universal use with anchors or without anchors in wood.

Steel Electrogalvanised, yellow passivated

Type	Diameter		Length	Contents PU pcs	Weight kg/PU	Shipping box PU	Item No.
	mm	mm					
SC016 3,5x15	3.50	15.00		200	0.14	30	904 37 1
SC016 3,5x20	3.50	20.00		200	0.18	30	904 37 2
SC016 3,5x25	3.50	25.00		200	0.24	30	904 37 3
SC016 3,5x30	3.50	30.00		200	0.33	30	904 37 4
SC016 3,5x35	3.50	35.00		200	0.34	20	904 37 5
SC016 3,5x40	3.50	40.00		200	0.42	16	904 37 6
SC016 3,5x45	3.50	45.00		200	0.44	16	904 37 7
SC016 3,5x50	3.50	50.00		200	0.48	16	904 37 8
SC016 4x15	4.00	15.00		200	0.20	30	904 37 9
SC016 4x20	4.00	20.00		200	0.28	30	904 38 0
SC016 4x25	4.00	25.00		200	0.35	30	904 38 1
SC016 4x30	4.00	30.00		200	0.44	20	904 38 2
SC016 4x35	4.00	35.00		200	0.50	16	904 38 3
SC016 4x40	4.00	40.00		200	0.54	16	904 38 4
SC016 4x45	4.00	45.00		200	0.56	16	904 38 5
SC016 4x50	4.00	50.00		200	0.62	12	904 38 6

Chipboard screw, panhead with combination Philips head (SC016)

For universal use with anchors or without anchors in wood.

Steel Electrogalvanised, yellow passivated

Type	Diameter		Length	Contents PU pcs	Weight kg/PU	Shipping box PU	Item No.
	mm	mm					
SC016 4,5x25	4.50	25.00		200	0.47	20	904 38 7
SC016 4,5x30	4.50	30.00		200	0.58	20	904 38 8
SC016 4,5x35	4.50	35.00		200	0.60	16	904 38 9
SC016 4,5x40	4.50	40.00		200	0.62	16	904 39 0
SC016 4,5x45	4.50	45.00		200	0.72	16	904 39 1
SC016 4,5x50	4.50	50.00		200	0.79	12	904 39 2
SC016 5x30	5.00	30.00		200	0.75	16	904 39 3
SC016 5x35	5.00	35.00		200	0.83	16	904 39 4
SC016 5x40	5.00	40.00		200	0.91	16	904 39 5
SC016 5x45	5.00	45.00		200	0.99	12	904 39 6
SC016 5x50	5.00	50.00		200	1.07	12	904 39 7
SC016 5x60	5.00	60.00		200	1.20	12	904 39 8
SC016 6x30	6.00	30.00		200	1.20	16	904 39 9
SC016 6x40	6.00	40.00		200	1.44	12	904 40 0
SC016 6x50	6.00	50.00		200	1.66	12	904 40 1
SC016 6x60	6.00	60.00		200	1.92	12	904 40 2



Chipboard screw, panhead with Torx (SC017)

For universal use with anchors or without anchors in wood.

Steel Electrogalvanised, yellow passivated

Type	Diameter		Length	Contents PU pcs	Weight kg/PU	Shipping box PU	Item No.
	mm	mm					
SC017 3,5x15	3.50	15.00		200	0.14	30	904 40 3
SC017 3,5x20	3.50	20.00		200	0.22	30	904 40 4
SC017 3,5x25	3.50	25.00		200	0.33	30	904 40 5
SC017 3,5x30	3.50	30.00		200	0.33	30	904 40 6
SC017 3,5x35	3.50	35.00		200	0.34	20	904 40 7
SC017 3,5x40	3.50	40.00		200	0.42	30	904 40 8
SC017 4x15	4.00	15.00		200	0.24	30	904 40 9
SC017 4x20	4.00	20.00		200	0.32	30	904 41 0
SC017 4x25	4.00	25.00		200	0.37	30	904 41 1
SC017 4x30	4.00	30.00		200	0.43	20	904 41 2
SC017 4x35	4.00	35.00		200	0.49	16	904 41 3
SC017 4x40	4.00	40.00		200	0.53	16	904 41 4
SC017 4x45	4.00	45.00		200	0.58	16	904 41 5
SC017 4x50	4.00	50.00		200	0.65	12	904 41 6
SC017 4,5x30	4.50	30.00		200	0.52	20	904 41 7
SC017 4,5x35	4.50	35.00		200	0.60	16	904 41 8
SC017 4,5x40	4.50	40.00		200	0.66	16	904 41 9
SC017 4,5x45	4.50	45.00		200	0.71	16	904 42 0
SC017 4,5x50	4.50	50.00		200	0.79	12	904 42 1
SC017 5x30	5.00	30.00		200	0.74	16	904 42 2
SC017 5x35	5.00	35.00		200	0.82	16	904 42 3
SC017 5x40	5.00	40.00		200	0.90	16	904 42 4
SC017 5x45	5.00	45.00		200	0.98	12	904 42 5
SC017 5x50	5.00	50.00		200	1.06	12	904 42 6



Device screw

CHARACTERISTIC:

- With self-tapping thread
- With combination Philips drive, offers more options for screwdriver selection
- Special slot drive prevents slippage to the side



Device screw, countersunk head, with combination Philips (SC024)

For device fastening of switching inserts and sockets in concealed or cavity wall boxes. Also for lid fastening.

Steel Electrogalvanised

Type	Diameter		Length	Contents PU pcs	Weight kg/PU	Shipping box PU	Item No.
	mm	mm					
SC024 3,2x15	3.20	15.00		100	0.09	1	930 20 0
SC024 3,2x25	3.20	25.00		100	0.10	1	930 20 1
SC024 3,2x40	3.20	40.00		100	0.16	1	930 20 2

INSTRUCTIONS FOR USE:

- The M6 anchor is knocked in using a flattener without hand protection (KS170)

Knock-in anchor M6 (KS266,KS274,KS282)

To fasten clips on concrete without anchors.

Steel, Hardened Electrogalvanised

Type	Shank Ø	Nail length	Contents PU pcs	Weight kg/PU	Shipping box PU	Item No.
	mm	mm				
KS274 8x15	8.00	15.00	100	0.31	70	957 10 6
KS282 8x18	8.00	18.00	100	0.37	70	957 09 4
KS282 8x25	8.00	25.00	100	0.43	70	957 11 0
KS282 8x30	8.00	30.00	100	0.49	70	957 11 2
KS282 8x40	8.00	40.00	100	0.59	70	957 11 6
KS266 8x55	8.00	55.00	100	0.69	70	957 11 8
KS266 8x70	8.00	70.00	100	0.84	40	957 12 0



Flattener without hand protection (KS170)

Item 903512:

For knocking in M6 anchors, painted red.

The red colour allows easy detection of the grip area.

The unpainted end contains the 10 mm-deep seat for the head of the M6 knock-in anchor.

Item 903516:

Not painted.

Steel Electrogalvanised

Type	Colour	Dimension	Contents	Weight	Shipping	Item No.
			PU pcs	kg/PU	box PU	
KS170 M6	Red	M6	1	0.15	1	903 51 2
KS170 M6	—	M6	1	0.16	1	903 51 6



Knock-in anchor Fixpin

Fixpin

The quick kind with a collar for secure knocking in

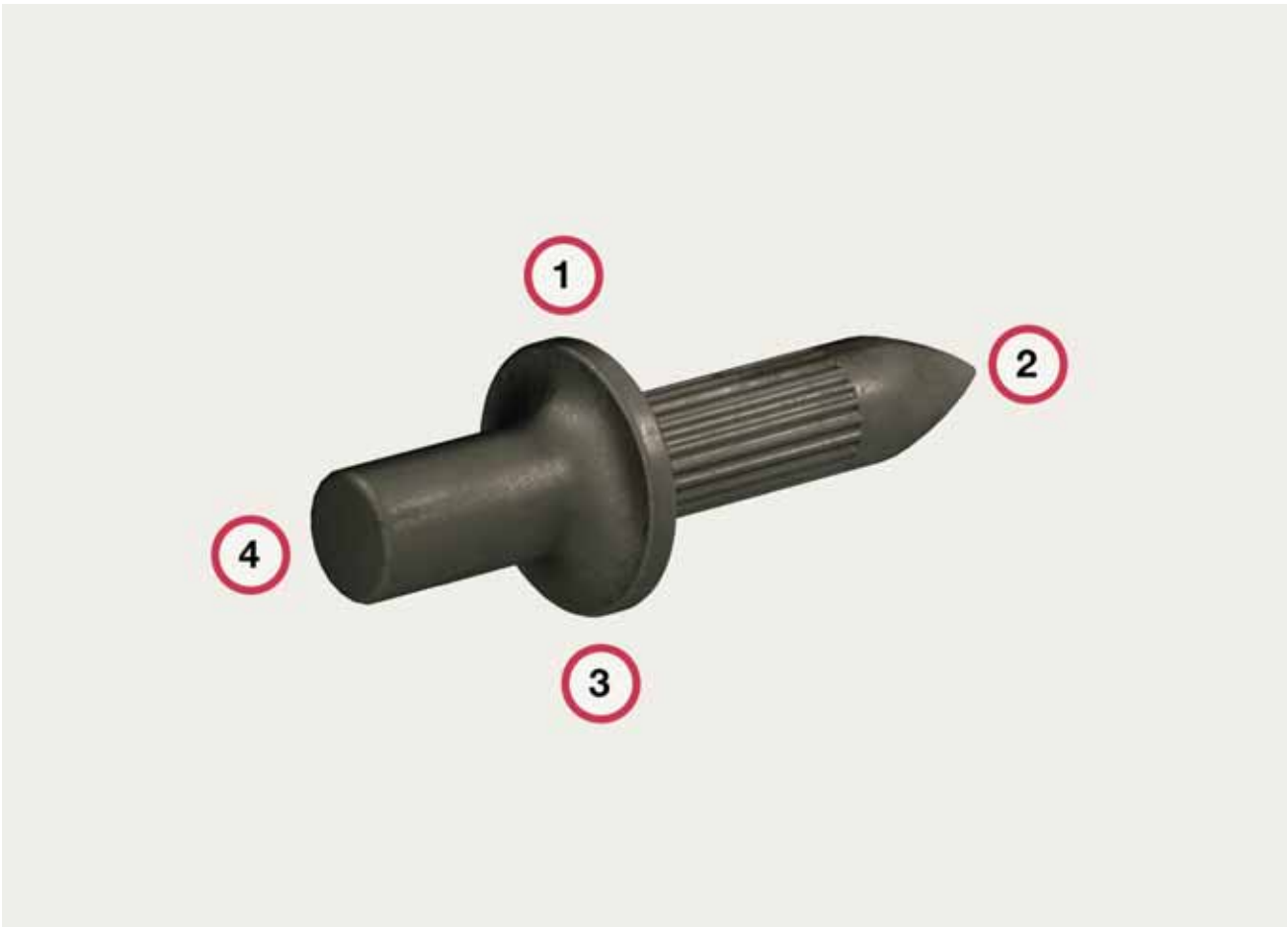

Four good reasons for our quick knock-in anchors

1. Accurate mounting

The countersunk collar adjusts itself automatically to the fastening hole

2. Perfect tip

The ballistic tip simplifies entry, even in the hardest concrete

3. High contact pressure thanks to the countersunk collar

4. Simple, safe knocking in with the flattener

No power supply or other tool required

CHARACTERISTIC:

- Manufactured from special electric steel with a high carbon content
- Hardened and annealed on modern, fully-automatic production lines in a continuous process under strict quality control
- High-hardness Fixpin, coupled with an extremely high tensile and break resistance to ensure absolute safety during work
- The Fixpin flattener is made from a high-quality tool steel and is hardened according to the DIN 7255 safety standard, according to the recommendations of the employment insurance companies
- The Fixpin flattener has hand protection, thus allowing safe knocking in

INSTRUCTIONS FOR USE:

- Insert the Fixpin nail into the flattener (black grip) up to the collar. If inserted correctly, the Fixpin will remain in the flattener
- Knock in with a hammer or club hammer. Only work with a flattener (black grip)
- Fixpin SFP/FP 14 and 18: Direct mounting of clips and perforated strip on concrete for electrical and heating installation
- Fixpin SFP/FP 18: Direct mounting of glue, spring or storm ties
- Fixpin SFP/FP 35 and 40: Mounting with increased fastening strength for slats, etc.

Fixpin knock-in anchor, smooth, small collar (KS233)

For quick and cost-saving mounting of pipes on raw concrete before the screed is applied (low-cost alternative to shooting).

Steel, Hardened Bright

Type	Shank Ø mm	Nail length mm	Contents PU pcs	Weight kg/PU	Shipping box PU	Item No.
FP 4/9x14	4.00	14.00	200	0.47	50	950 88 4
FP 4/9x18	4.00	18.00	200	0.57	50	950 89 2
FP 4/9x22	4.00	22.00	200	0.64	50	950 98 0
FP 4/9x27	4.00	27.00	100	0.36	50	950 99 9
FP 4/9x35	4.00	35.00	100	0.43	50	950 86 8
FP 4/9x40	4.00	40.00	100	0.48	50	950 87 6



Fixpin knock-in anchor, smooth, small collar, case set

Set consists of:

- 1 case
- 1 Fixpin flattener with hand protection, black
- 1 hammer (1 kg)
- 10 boxes, each containing 200 units of Fixpin FP 18 mm

Steel, Hardened Bright

Type	Shank Ø mm	Nail length mm	Contents PU pcs	Weight kg/PU	Shipping box PU	Item No.
FP 18	4.00	18.00	1	10.76	1	950 80 3

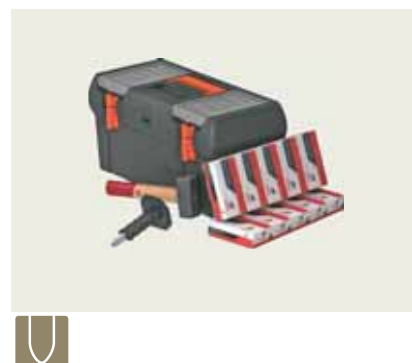

Knock-in anchor Fixpin



Fixpin knock-in anchor, lengthwise fluting, large collar (KS199)

For quick and cost-saving mounting of pipes on raw concrete before the screed is applied (low-cost alternative to shooting).

Steel, Hardened Bright

Type	Shank Ø mm	Nail length mm	Contents PU pcs	Weight kg/PU	Shipping box PU	Item No.
SFP 4x14	4.00	14.00	200	0.61	50	950 80 0
SFP 4x18	4.00	18.00	200	0.67	50	950 81 0
SFP 4x22	4.00	22.00	200	0.73	50	950 82 0
SFP 4x27	4.00	27.00	100	0.43	50	950 82 5
SFP 4x35	4.00	35.00	100	0.52	50	950 82 8
SFP 4x40	4.00	40.00	100	0.57	50	950 83 3



Flattener with hand protection (KS207)

For knocking in a Fixpin with \varnothing 4 mm. The flattener with a black grip is not suitable for breakable Fixpins.

Steel Electrogalvanised

Type	Colour	Dimension	Contents PU pcs	Weight kg/PU	Shipping box PU	Item No.
KS207 4	Black	4	1	0.49	1	903 00 9



Fixpin knock-in anchor, lengthwise fluting, large collar, case set

Set consists of:

- 1 case
- 1 Fixpin flattener with hand protection, black
- 1 hammer (1 kg)
- 10 boxes, each containing 200 units of Fixpin SFP 18 mm

Steel, Hardened Bright

Type	Shank Ø mm	Nail length mm	Contents PU pcs	Weight kg/PU	Shipping box PU	Item No.
SFP 18	4.00	18.00	2,000	10.50	1	950 80 4



Fixpin knock-in anchor, lengthwise fluting, large collar, case set and installation strip

Set consists of:

- 1 case
- 1 Fixpin flattener with hand protection, black
- 1 hammer (1 kg)
- 10 boxes, each containing 200 units of Fixpin SFP 18 mm
- 2 rolls of 10 metres of galvanised metal mounting strip

Steel, Hardened Bright

Type	Shank Ø mm	Nail length mm	Contents PU pcs	Weight kg/PU	Shipping box PU	Item No.
SFP 18	4.00	18.00	1	12.00	1	950 79 5

Knock-in anchor with predetermined breaking point

CHARACTERISTIC:

- Manufactured from special electric steel with a high carbon content
- Hardened and annealed on modern, fully-automatic production lines in a continuous process under strict quality control
- High-hardness Fixpin, coupled with an extremely high tensile and break resistance to ensure absolute safety during work
- The Fixpin flattener is made from a high-quality tool steel and is hardened according to the DIN 7255 safety standard, according to the recommendations of the employment insurance companies
- The Fixpin flattener has hand protection, thus allowing safe knocking in

INSTRUCTIONS FOR USE:

- Insert the Fixpin nail into the flattener (red grip) up to the collar. If inserted correctly, the Fixpin will remain in the flattener
- Knock in with a hammer or club hammer. Only work with a flattener (red grip)
- Fixpin FPG 18: Direct mounting of glue, spring or storm ties as well as clips and perforated strip on concrete for electrical and heating installations
- Knock in the Fixpin with predetermined breaking point with the special flattener (red grip) and a 1 kg club hammer. After knocking in, the accepting mandrel can be broken off easily using the flattener
- Caution: Do not use the standard flattener (black grip) for the Fixpin predetermined breaking point

Fixpin knock-in anchor, lengthwise fluting, small collar, predetermined breaking point (KS243)

For quick and cost-saving mounting of pipes on raw concrete before the screed is applied (low-cost alternative to shooting).

Steel, Hardened Bright

Type	Shank Ø	Nail length	Contents PU	Weight	Shipping box	Item No.
	mm	mm	pcs	kg/PU	PU	
FPG 4x18	4.00	18.00	200	0.54	50	950 93 0



Fixpin knock-in anchor, lengthwise fluting, large collar, predetermined breaking point (KS284)

For quick and cost-saving mounting of pipes on raw concrete before the screed is applied (low-cost alternative to shooting).

Steel, Hardened Bright

Type	Shank Ø	Nail length	Contents PU	Weight	Shipping box	Item No.
	mm	mm	pcs	kg/PU	PU	
FPG 4x18	4.00	18.00	200	0.70	50	950 93 2



Knock-in anchor with predetermined breaking point

Flattener with hand protection (KS207)

For knocking in a Fixpin with \varnothing 4 mm. The flattener with a red grip is only suitable for breakable Fixpins.
Steel Electrogalvanised



Type	Colour	Dimension	Contents PU pcs	Weight kg/PU	Shipping box PU	Item No.
KS246 4	Red	4	1	0.53	1	903 01 0

CHARACTERISTIC:

- High-quality anchor (PA-6)
- High extraction value
- Halogen and silicone-free

Full material anchor without collar (PG037)

High-quality nylon anchor for secure screw retention. Fins prevent the anchor from turning.

Polyamide

Type	Colour	Dowel Ø		Anchor length	Contents PU	Weight	Shipping box	Item No.
		mm	mm					
NP 5x25	Grey	5.00	25.00		100	0.03	50	955 00 1
NP 6x30	Grey	6.00	30.00		100	0.06	50	955 02 8
NP 8x40	Grey	8.00	40.00		100	0.14	25	955 03 6
NP 10x50	Grey	10.00	50.00		50	0.13	25	955 04 4
NP 12x60	Grey	12.00	60.00		25	0.12	25	955 05 2
NP 14x60	Grey	14.00	60.00		25	0.08	25	955 05 4



Full material anchor with collar (PG038)

High-quality nylon anchor for secure screw retention. Fins prevent the anchor from turning.

The collar prevents the anchor from slipping.

Polyamide

Type	Colour	Dowel Ø		Anchor length	Contents PU	Weight	Shipping box	Item No.
		mm	mm					
PG038 5x25	Grey	5.00	25.00		100	0.04	50	905 12 1
PG038 6x30	Grey	6.00	30.00		100	0.05	50	905 12 2
PG038 8x40	Grey	8.00	40.00		100	0.12	25	905 12 3
PG038 10x50	Grey	10.00	50.00		100	0.11	25	905 12 4
PG038 12x60	Grey	12.00	60.00		100	0.08	25	905 12 5



Universal (cavity wall) anchor without collar (PG039)

For universal screw fastening in concrete, stone, gas concrete, hollow brick or plasterboard plate.

Polyamide

Type	Colour	Dowel Ø		Anchor length	Contents PU	Weight	Shipping box	Item No.
		mm	mm					
PG039 5x32	Grey	5.00	32.00		100	0.02	50	905 12 6
PG039 6x36	Grey	6.00	36.00		100	0.05	50	905 12 7
PG039 8x50	Grey	8.00	50.00		100	0.11	25	905 12 8
PG039 10x60	Grey	10.00	60.00		50	0.10	25	905 12 9
PG039 12x70	Grey	12.00	70.00		25	0.08	25	905 13 0
PG039 14x75	Grey	14.00	75.00		25	0.11	25	905 13 1



Anchor for screw

Universal (cavity wall) anchor for screw with collar (PG040)



For universal screw fastening in concrete, stone, gas concrete, hollow brick or plasterboard plate. The collar prevents the anchor from slipping.

Polyamide

Type	Colour	Dowel Ø mm	Anchor length mm	Contents PU pcs	Weight kg/PU	Shipping box PU	Item No.
PG040 5x32	Grey	5.00	32.00	100	0.03	50	905 13 2
PG040 6x36	Grey	6.00	36.00	100	0.05	50	905 13 3
PG040 8x50	Grey	8.00	50.00	100	0.11	50	905 13 4
PG040 10x60	Grey	10.00	60.00	50	0.10	25	905 13 5
PG040 12x70	Grey	12.00	70.00	25	0.08	25	905 13 6
PG040 14x75	Grey	14.00	75.00	25	0.11	25	905 13 7



Speedplug

The perfect combination of functionality and quality

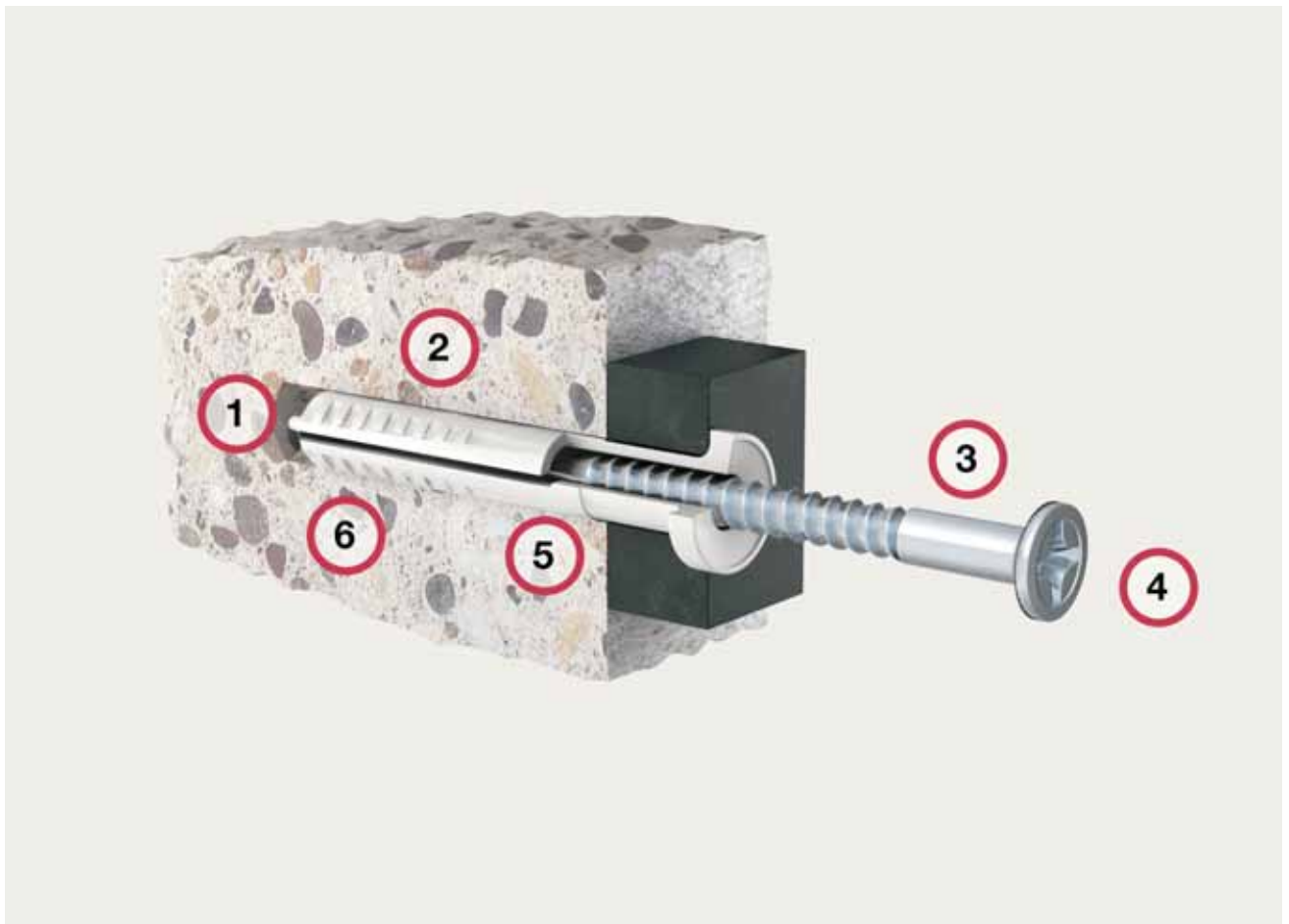

Six decisive arguments for the Speedplug nail anchor

1. Easy knocking-in

- Thanks to precise nail guidance

2. Nylon anchors

- Tear-resistant, heat and cold-resistant
- Resistant to aging

3. Galvanised nail

- For a high level of rust resistance

4. Impact-protected Philips head

- For easy dismantling

5. Knock-in lock

- Prevents premature spreading

6. Special Don Quichotte anchor profile

- Maximum contact area = Maximum extraction value

Knock-in / nail anchor

Anchor material:	Polyamide (PA-6)
Nail material:	Steel, tensile strength 500–700 N/mm ²
Nail surface:	Electrogalvanised

Diameter [mm]	Extraction value [KN]
5	0.9–1.3
6	1.6–1.8
8	2.4–2.9
10	3.0–3.5

CAUTION: These are average extraction values in concrete or stone with a safety factor of between 4.5 and 5.



Speedplug SP, flat collar, cylinder head

Nail anchor for electrical engineers, sanitary installation engineers, drywall builders and roofers. Pre-mounted knock-in for the mounting of clips, profiles and slats on concrete and calcareous limestone, etc.

Polyamide

Type	Colour	Dowel Ø mm	Anchor length mm	Contents PU pcs	Weight kg/PU	Shipping box PU	Item No.
SP 4x25	Natural	4.00	25.00	200	0.35	10	998 70 5
SP 5x25	Natural	5.00	25.00	200	0.54	10	998 71 0
SP 5x30	Natural	5.00	30.00	200	0.55	10	998 70 6
SP 5x35	Natural	5.00	35.00	200	0.60	10	999 10 0
SP 5x45	Natural	5.00	45.00	200	0.84	10	999 11 9
SP 6x40	Natural	6.00	40.00	200	0.91	10	999 38 9
SP 6x35	Natural	6.00	35.00	200	0.77	10	999 39 0
SP 6x55	Natural	6.00	55.00	200	1.16	10	999 39 7
SP 6x70	Natural	6.00	70.00	100	0.76	10	998 26 3
SP 6x80	Natural	6.00	80.00	100	0.84	10	998 26 4
SP 8x55	Natural	8.00	55.00	100	0.97	10	998 27 1
SP 8x70	Natural	8.00	70.00	100	1.17	10	998 29 8
SP 8x100	Natural	8.00	100.00	100	1.57	10	998 30 0



Speedplug SP-E, flat collar, cylinder head

Nail anchor especially for electrical installation.

Pre-mounted knock-in for the mounting of clips, profiles and slats on concrete and calcareous limestone, etc.

Polyamide

Type	Colour	Dowel Ø mm	Anchor length mm	Contents PU pcs	Weight kg/PU	Shipping box PU	Item No.
SP-E 6x35	Natural	6.00	35.00	200	0.77	10	998 76 0
SP-E 6x40	Natural	6.00	40.00	200	0.91	10	998 76 6
SP-E 6x55	Natural	6.00	55.00	200	1.16	10	998 76 4
SP-E 6x70	Natural	6.00	70.00	100	0.76	10	998 76 2

Speedplug SPKK, countersunk collar, countersunk head

Nail anchor for electrical engineers, sanitary installation engineers, drywall builders and roofers. Pre-mounted knock-in for the mounting of clips, profiles and slats on concrete and calcareous limestone, etc.

Polyamide

Type	Colour	Dowel Ø mm	Anchor length mm	Contents PU pcs	Weight kg/PU	Shipping box PU	Item No.
SPKK 5x35	Natural	5.00	35.00	200	0.63	10	951 00 0
SPKK 5x45	Natural	5.00	45.00	200	0.79	10	951 01 9
SPKK 6x40	Natural	6.00	40.00	200	0.91	10	931 70 4
SPKK 6x60	Natural	6.00	60.00	200	1.17	10	931 71 2
SPKK 6x70	Natural	6.00	70.00	100	0.76	10	931 72 0
SPKK 6x80	Natural	6.00	80.00	100	0.84	10	931 72 3
SPKK 8x60	Natural	8.00	60.00	100	1.01	10	931 73 9
SPKK 8x80	Natural	8.00	80.00	100	1.30	10	931 74 7
SPKK 8x100	Natural	8.00	100.00	100	1.58	10	931 75 5
SPKK 8x120	Natural	8.00	120.00	100	1.94	10	943 91 3



Speedplug SPKK, countersunk collar, countersunk head

Nail anchor for electrical engineers, sanitary installation engineers, drywall builders and roofers. Pre-mounted knock-in for the mounting of clips, profiles and slats on concrete and calcareous limestone, etc.

Polyamide

Type	Colour	Dowel Ø mm	Anchor length mm	Contents PU pcs	Weight kg/PU	Shipping box PU	Item No.
SPKK 5x45	Grey	5.00	45.00	100	0.40	10	951 02 1
SPKK 6x40	Grey	6.00	40.00	100	0.46	10	931 70 8
SPKK 6x60	Grey	6.00	60.00	100	0.59	10	931 72 5
SPKK 6x70	Grey	6.00	70.00	50	0.38	10	931 72 6
SPKK 8x60	Grey	8.00	60.00	50	0.51	10	931 74 1
SPKK 8x80	Grey	8.00	80.00	50	0.65	10	931 74 6
SPKK 8x100	Grey	8.00	100.00	50	0.79	10	931 75 3



Speedplug SPM M6, countersunk collar, countersunk head

Nail anchor for electrical engineers and sanitary installation engineers for clip fastening using an M6 thread.

Polyamide

Type	Colour	Dowel Ø mm	Anchor length mm	Thread size M	Thread increase mm	Contents PU pcs	Weight kg/PU	Shipping box PU	Item No.
SPM 6x40	Natural	6.00	40.00	6.00	1.00	200	1.33	10	960 00 3
SPM 6x80	Natural	6.00	80.00	6.00	1.00	100	0.96	10	943 11 5



Knock-in / nail anchor



Speedplug SPM M7, countersunk collar, countersunk head

Nail anchor for electrical engineers and sanitary installation engineers for clip fastening using an M7 thread.

Polyamide

Type	Colour	Dowel Ø mm	Anchor length mm	Thread size M	Thread increase mm	Contents PU pcs	Weight kg/PU	Shipping box PU	Item No.
SPM 7/1,0 6x40	Natural	6.00	40.00	7.00	1.00	200	1.19	10	960 30 2
SPM 7/1,5 6x40	Natural	6.00	40.00	7.00	1.50	200	1.40	10	962 69 0



Speedplug SPM M8, countersunk collar, countersunk head

Nail anchor for electrical engineers and sanitary installation engineers for clip fastening using an M8 thread.

Polyamide

Type	Colour	Dowel Ø mm	Anchor length mm	Thread size M	Thread increase mm	Contents PU pcs	Weight kg/PU	Shipping box PU	Item No.
SPM 8x45	Natural	8.00	45.00	8.00	1.00	100	1.08	10	960 04 6
SPM 8x60	Natural	8.00	60.00	8.00	1.00	100	1.26	10	943 88 7
SPM 8x80	Natural	8.00	80.00	8.00	1.00	100	1.54	10	943 89 5



Speedplug SPP, countersunk collar, countersunk head

To fasten panels.

Polyamide

Type	Colour	Dowel Ø mm	Anchor length mm	Contents PU pcs	Weight kg/PU	Shipping box PU	Item No.
SPP 5x35	Brown	5.00	35.00	200	0.72	10	970 02 5
SPP 5x45	Brown	5.00	45.00	200	0.84	10	970 03 3



Speedplug SPP, countersunk collar, countersunk head

To fasten panels.

Polyamide

Type	Colour	Dowel Ø mm	Anchor length mm	Contents PU pcs	Weight kg/PU	Shipping box PU	Item No.
SPP 5x35	White	5.00	35.00	200	0.72	10	970 04 1
SPP 5x45	White	5.00	45.00	200	0.84	10	970 08 4

Speedplug SPHZ, wide collar, countersunk head

To fasten wood on full material, such as concrete, hollow brick, etc.

Polyamide

Type	Colour	Dowel Ø	Anchor length	Contents PU	Weight	Shipping box	Item No.
		mm	mm	pcs	kg/PU	PU	
PL042 8x50	Natural	8.00	50.00	200	1.79	10	994 40 2



Speedplug SPTB, mushroom collar, mushroom head

To fasten cable ducts, etc.

Polyamide

Type	Colour	Dowel Ø	Anchor length	Contents PU	Weight	Shipping box	Item No.
		mm	mm	pcs	kg/PU	PU	
SPTB 6x40	Natural	6.00	40.00	200	0.80	10	999 40 2
SPTB 6x50	Natural	6.00	50.00	200	0.99	10	999 40 1
SPTB 6x60	Natural	6.00	60.00	200	1.17	10	999 40 0



Speedplug SPA2, flat collar, cylinder head

Nail anchor for electrical engineers, sanitary installation engineers, drywall builders and roofers. Pre-mounted knock-in for the mounting of clips, profiles and slats on concrete and calcareous limestone, etc.

Polyamide

Type	Colour	Dowel Ø	Anchor length	Contents PU	Weight	Shipping box	Item No.
		mm	mm	pcs	kg/PU	PU	
SP 5x30	Natural	5.00	30.00	200	0.55	10	999 40 3
SP 5x35	Natural	5.00	35.00	200	0.72	10	999 39 4
SP 6x40	Natural	6.00	40.00	200	0.91	10	999 40 6
SP 6x55	Natural	6.00	55.00	200	1.16	10	999 40 7
SP 6x70	Natural	6.00	70.00	100	0.76	10	999 40 8
SP 8x70	Natural	8.00	70.00	100	1.17	10	999 41 1



Hammer plug KPA, countersunk collar, countersunk head

To fasten window and door frames.

Polyamide

Type	Colour	Dowel Ø	Anchor length	Contents PU	Weight	Shipping box	Item No.
		mm	mm	pcs	kg/PU	PU	
KPA 8x120	Natural	8.00	120.00	100	1.94	10	943 90 9
KPA 8x140	Natural	8.00	140.00	100	2.30	10	943 91 9
KPA 10x100	Natural	10.00	100.00	50	1.39	10	943 91 7
KPA 10x120	Natural	10.00	120.00	50	1.63	10	943 92 5
KPA 10x140	Natural	10.00	140.00	50	1.96	10	943 92 0
KPA 10x160	Natural	10.00	160.00	50	2.23	10	943 92 1



Hammer plug KPA, countersunk collar, countersunk head

To fasten window and door frames.

Polyamide



Type	Colour	Dowel Ø mm	Anchor length mm	Contents PU pcs	Weight kg/PU	Shipping box PU	Item No.
KPA 8x120	Grey	8.00	120.00	50	0.97	10	945 13 4
KPA 10x100	Grey	10.00	100.00	25	0.70	10	945 16 3
KPA 10x120	Grey	10.00	120.00	25	0.81	10	945 19 0
KPA 10x140	Grey	10.00	140.00	25	0.98	10	945 19 8
KPA 10x160	Grey	10.00	160.00	25	1.11	10	945 20 8

Total-Fixx

This one'll go through thick and thin for you

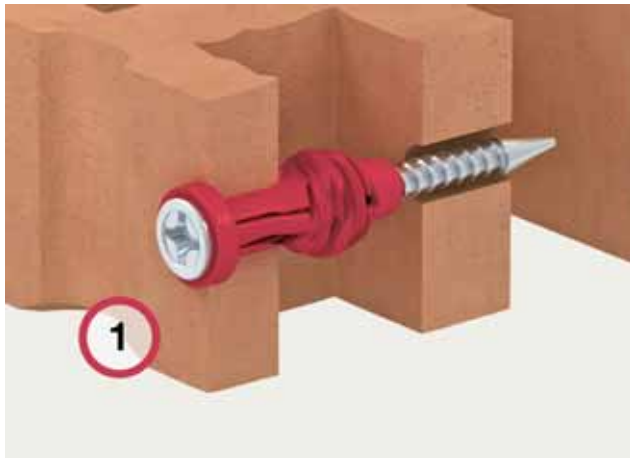

Four arguments for "one for all":

1. Fastening, even in difficult substrates

- E.g. in concrete, hollow bricks, plasterboard plates, gas concrete, etc.

2. Time savings

- As pre-mounted and suitable for pass-through mounting

3. Galvanised nail with impact-protected Philips head

- For a high level of rust resistance and easy dismantling

4. Nylon anchors with flat collar

- Tear-resistant, heat and cold-resistant
- Resistant to aging

Knock-in, nail and screw anchor Total-Fixx

CHARACTERISTIC:

- A nail anchor for knocking in or screwing into difficult substrates, such as plasterboard, hollow brick and gas concrete
- Especially suitable for mounting in electrical installations and internal extensions
- To be used for fastening thicknesses of up to 5 mm
- Total-Fixx is pre-mounted and allows pass-through mounting

Anchor material:	Polyamide (PA-6)
Nail material:	Steel, tensile strength 500 – 700 N/mm ²
Nail surface:	Electrogalvanised
Drive:	Pozi 2 (PZ 2)

Drill hole	TF 5x30 [mm]	TF 6x40 [mm]
Depth	35	45
Diameter	5	6

Substrate	TF 5x30 [KN]	TF 6x40 [KN]
Concrete	0.15	0.25
Hollow stone	0.07	0.10
Plasterboard plate	0.07	0.10
Gas concrete	0.13	0.14

CAUTION: These are average extraction values with a minimum safety factor of 5.



Total-Fixx TF, flat collar, cylinder head

Fastening in all types of substrates.

Polyamide

Type	Colour	Dowel Ø mm	Anchor length mm	Contents PU pcs	Weight kg/PU	Shipping box PU	Item No.
TF 5x30	Red	5.00	30.00	200	0.55	10	970 12 2
TF 6x40	Red	6.00	40.00	200	0.84	10	970 16 5



CHARACTERISTIC:

- No special tool is required for Gips-Fixx – simple knock it in horizontally with a hammer
- The ZAMAK plasterboard anchor can be turned in simply using a screwdriver without pre-drilling
- Suitable for all standard plasterboard plates and cavity materials

Gips-Fixx, metal L (MZ026)

For mounting in all standard plasterboard plates. Type L up to 12 mm material thickness. Suitable for screws with a \varnothing of 3.5 to 4.5 mm.

Steel Galvanised

Type	Dimension	Dowel \varnothing	Anchor length	Contents PU	Weight	Shipping box	Item No.
		mm	mm	pcs	kg/PU	PU	
MZ026 L	12	12.00	30.00	100	0.19	70	970 18 2



Gips-Fixx, metal XL (MZ028)

For mounting in all standard plasterboard plates. Type XL up to 24 mm material thickness. Suitable for screws with a \varnothing of 4.0 to 5.0 mm.

Steel Galvanised

Type	Dimension	Dowel \varnothing	Anchor length	Contents PU	Weight	Shipping box	Item No.
		mm	mm	pcs	kg/PU	PU	
MZ028 XL	24	16.00	43.00	100	0.50	70	970 18 4



Plasterboard anchor, ZAMAK, turn-in (PG042)

Simply screw into the plasterboard plate with a Philips drive. The thread is self-tapping. Then the object can be fastened using a screw (\varnothing 4–5 mm).

Die-cast zinc

Type	Dowel \varnothing	Anchor length	Pack.	Contents PU	Weight	Shipping box	Item No.
	mm	mm	PU	pcs	kg/PU	PU	
PG042	12.60	31.00	1.00	100	0.45	20	905 13 9



Plasterboard anchor, plastic, turn-in (PG041)

Simply screw into the plasterboard plate with a Philips drive. The thread is self-tapping. Then the object can be fastened using a screw (\varnothing 4–5 mm).

Polyamide

Type	Colour	Dowel \varnothing	Anchor length	Contents PU	Weight	Shipping box	Item No.
		mm	mm	pcs	kg/PU	PU	
PG041	Grey	12.40	37.80	100	0.18	40	905 13 8



Full plastic anchor

CHARACTERISTIC:

- Easy to knock in
- Corrosion-free
- Can be used in concrete, full brick, calcareous sandstone, wood and other solid materials
- Quick, solid and decorative fastening

TECHNICAL DATA:

- Plastic PA-6 is halogen and silicone-free
- Temperature resistance: 80 °C long-term, 130 °C short-term
- Plastic, flame-resistant acc. to UL 94 HB
- UV-resistant. The product can be used under UV-radiation in both dry warm, and humid warm, climates for at least 5 years, without any loss in the use properties
- Max. extraction force: 400 Nm
- Max. shear stress: 600 Nm



Full plastic anchor VK, white RAL9010 (VK001)

To fasten wooden panels, skirting boards, cable ducts, plasterboard plates, windowsills, etc.
Polyamide

Type	Colour	Dowel Ø mm	Anchor length mm	Contents PU pcs	Weight kg/PU	Shipping box PU	Item No.
VK 6x40	White	6.00	40.00	200	0.19	16	955 09 3



Full plastic anchor VK, grey RAL7035 (VK001)

To fasten wooden panels, skirting boards, cable ducts, plasterboard plates, windowsills, etc.
Polyamide

Type	Colour	Dowel Ø mm	Anchor length mm	Contents PU pcs	Weight kg/PU	Shipping box PU	Item No.
VK 6x40	Grey	6.00	40.00	200	0.19	16	955 09 5



Full plastic anchor VK, black RAL9011 (VK001)

To fasten wooden panels, skirting boards, cable ducts, plasterboard plates, windowsills, etc.
Polyamide

Type	Colour	Dowel Ø mm	Anchor length mm	Contents PU pcs	Weight kg/PU	Shipping box PU	Item No.
VK 6x40	Black	6.00	40.00	200	0.19	16	955 09 7

Full plastic anchor VK, brown RAL8004 (VK001)

To fasten wooden panels, skirting boards, cable ducts, plasterboard plates, windowsills, etc.

Polyamide

Type	Colour	Dowel Ø	Anchor length	Contents PU	Weight	Shipping box	Item No.
		mm	mm	pcs	kg/PU	PU	
VK 6x40	Brown	6.00	40.00	200	0.19	16	955 09 4



Full plastic anchor VK, light brown RAL8001 (VK001)

To fasten wooden panels, skirting boards, cable ducts, plasterboard plates, windowsills, etc.

Polyamide

Type	Colour	Dowel Ø	Anchor length	Contents PU	Weight	Shipping box	Item No.
		mm	mm	pcs	kg/PU	PU	
VK 6x40	Light brown	6.00	40.00	200	0.19	16	955 09 6



Full plastic anchor for cable ties

CHARACTERISTIC:

- Easy to knock in
- Corrosion-free
- Can be used in concrete, full brick, calcareous sandstone, wood and other solid materials
- Quick and solid fastening
- For cable ties of up to 9 mm
- For drill hole with \varnothing 6 mm or \varnothing 8 mm (depending on version)



Full plastic anchor for cable ties VKKL (VK002)

To fasten pipes or cables with a cable tie (9 mm).

Polyamide

Type	Colour	Dowel \varnothing	Anchor length	Contents PU	Weight	Shipping box	Item No.
		mm	mm	pcs	kg/PU	PU	
VKKL 6x40	Black	6.00	40.00	200	0.33	12	955 09 8
VKKL 8x40	Black	8.00	40.00	100	0.19	16	955 10 1



Full plastic anchor for cable ties VKKH (VK004)

To fasten pipes or cables with a cable tie (9 mm). Ensures additional space between the pipe/cable and the substrate.

Polyamide

Type	Colour	Dowel \varnothing	Anchor length	Contents PU	Weight	Shipping box	Item No.
		mm	mm	pcs	kg/PU	PU	
VKKH 6x40	Black	6.00	40.00	100	0.22	16	955 09 9

CHARACTERISTIC:

- With threaded rod, washer and nut
- Available with or without ceiling hook

Sprung-hinged anchor with ceiling hook (SC023)

For rapid fastening in false ceilings.

Steel Electrogalvanised

Type	Length mm	Drill hole Ø mm	Thread size M	Contents PU pcs	Weight kg/PU	Shipping box PU	Item No.
SC023 M4x70	70.00	14	4.00	50	0.98	10	904 45 1



Sprung-hinged anchor without ceiling hook (SC022)

For rapid fastening in false ceilings.

Steel Electrogalvanised

Type	Length mm	Drill hole Ø mm	Thread size M	Contents PU pcs	Weight kg/PU	Shipping box PU	Item No.
SC022 M4x95	95.00	14	4.00	50	0.88	10	904 45 0



Tilting anchor

CHARACTERISTIC:

- With threaded rod, washer and nut
- Available with or without ceiling hook



Tilting anchor with ceiling hook (SC021)

For rapid fastening in false ceilings.

Steel Electrogalvanised

Type	Length mm	Drill hole Ø mm	Thread size M	Contents PU pcs	Weight kg/PU	Shipping box PU	Item No.
SC021 M4x55	55.00	13	4.00	50	1.63	8	904 45 3
SC021 M5x65	65.00	13	5.00	50	1.93	6	904 44 8
SC021 M5x100	100.00	16	6.00	50	2.13	6	904 44 9



Tilting anchor without ceiling hook (SC020)

For rapid fastening in false ceilings.

Steel Electrogalvanised

Type	Length mm	Drill hole Ø mm	Thread size M	Contents PU pcs	Weight kg/PU	Shipping box PU	Item No.
SC020 M4x100	100.00	13	4.00	50	1.66	8	904 45 4
SC020 M5x100	100.00	13	5.00	50	1.91	8	904 45 2
SC020 M6x100	100.00	16	6.00	50	2.63	6	904 44 7

CHARACTERISTIC:

- Internal toothing
- Cable tie for use in the electrical installation according to DIN EN 62275 VDE 0604-201:2010-07
- With plastic tongue/tab

TECHNICAL DATA:

- Polyamide 6.6, halogen-free
- UL approval 94, Class V2
- Application temperature: -40 °C to +85 °C
- Mounting temperature: -10 °C to +60 °C
- Melting point at 256 °C

Cable tie, standard, natural (OZ066)

With plastic tongue/tab, according to DIN EN 62275 VDE 0604-201:2010-07
oxygen index [LOI]: 27%, moisture intake 2.7% at 50% relative humidity

Type	Colour	Width mm	Length mm	Bundle ø, max. mm	Thickness mm	Contents PU pcs	Weight kg/PU	Shipping box PU	Item No.
OZ066 2,5x98	Natural	2.50	98.00	21.00	1.00	100	0.03	1	904 60 0
OZ066 2,5x135	Natural	2.50	135.00	32.00	1.00	100	0.04	1	904 60 2
OZ066 2,6x200	Natural	2.60	200.00	52.00	1.00	100	0.07	1	904 60 4
OZ066 3,6x140	Natural	3.50	140.00	35.00	1.00	100	0.07	1	904 60 6
OZ066 3,6x200	Natural	3.50	200.00	50.00	1.20	100	0.10	1	904 60 8
OZ066 4,8x200	Natural	4.50	200.00	50.00	1.35	100	0.16	1	904 61 2
OZ066 4,8x290	Natural	4.50	290.00	78.00	1.40	100	0.22	1	904 61 4
OZ066 4,8x360	Natural	3.50	290.00	80.00	1.20	100	0.15	1	904 61 0
OZ066 4,8x360	Natural	4.50	360.00	100.00	1.40	100	0.28	1	904 61 6
OZ066 7,5x540	Natural	7.50	540.00	158.00	1.75	100	0.81	1	904 61 8



Cable tie, standard, UV-resistant, black (OZ066)

The addition of carbon, means that it is UV-resistant according to EN ISO 4890, corresponds to approx. 3 years of sunlight, with plastic tongue/tab, according to DIN EN 62275 VDE 0604-201:2010-07
UL approval 94, Class V2

Use temperature -40 °C to 85 °C, mounting temperature -10 °C to 60 °C

Melting point at 256 °C

Oxygen index [LOI]: 27%, moisture intake 2.7% at 50% relative humidity

Type	Colour	Width mm	Length mm	Bundle ø, max. mm	Thickness mm	Contents PU pcs	Weight kg/PU	Shipping box PU	Item No.
OZ066 2,5x98	Black	2.50	98.00	21.00	1.00	100	0.03	1	904 60 1
OZ066 2,5x135	Black	2.50	135.00	32.00	1.00	100	0.04	1	904 60 3
OZ066 2,6x200	Black	2.60	200.00	52.00	1.00	100	0.07	1	904 60 5
OZ066 3,6x140	Black	3.50	140.00	35.00	1.00	100	0.07	1	904 60 7
OZ066 3,6x200	Black	3.50	200.00	50.00	1.20	100	0.10	1	904 60 9
OZ066 3,6x290	Black	3.50	290.00	80.00	1.20	100	0.15	1	904 61 1
OZ066 3,6x290	Black	4.50	200.00	50.00	1.35	100	0.16	1	904 61 3
OZ066 4,8x290	Black	4.50	290.00	78.00	1.40	100	0.22	1	904 61 5
OZ066 4,8x360	Black	4.50	360.00	100.00	1.40	100	0.28	1	904 61 7
OZ066 7,5x540	Black	7.50	540.00	158.00	1.75	100	0.81	1	904 61 9



Cable ties and accessories

CHARACTERISTIC:

- Self-adhesive
- 2-way fastening (horizontal or vertical)
- Simply stick the base to a flat surface and fasten the required object using cable ties
- Maximum cable tie size for
 - 19 x 19 mm: Width 4.1 mm, height 4 mm
 - 27 x 27 mm: Width 4.8 mm, height 6 mm

TECHNICAL DATA:

- Material ABS (acrylonitrile butadiene styrene)
- UL approval 94, Class HB
- For loads up to 0.36 kg/cm³ at +15 °C to +40 °C
- Application temperature: -10 °C to +60 °C



2-way fastening base for cable ties, natural (OZ067)

Self-adhesive, made of ABS (acrylonitrile butadiene styrene)
for loads of up to 0.36 kg/cm³ at 15 °C to 40 °C
Application temperature between -10 °C and 60 °C, UL approval 94-HB

Type	Colour	Width mm	Length mm	Max. bundle Ø mm	Contents PU pcs	Weight kg/PU	Shipping box PU	Item No.
OZ067 19x19 n	Natural	19.00	19.00	–	100	0.07	1	904 63 0
OZ066 27x27 n	Natural	27.00	27.00	–	100	0.18	1	904 63 2



2-way fastening base for cable ties, black (OZ067)

Self-adhesive, made of ABS (acrylonitrile butadiene styrene)
for loads of up to 0.36 kg/cm³ at 15 °C to 40 °C
Application temperature between -10 °C and 60 °C, UL approval 94-HB

Type	Colour	Width mm	Length mm	Max. bundle Ø mm	Contents PU pcs	Weight kg/PU	Shipping box PU	Item No.
OZ067 19x19 s	Black	19.00	19.00	–	100	0.07	1	904 63 1
OZ066 27x27 s	Black	19.00	19.00	–	100	0.18	1	904 63 3



CHARACTERISTIC:

- Outer toothing to avoid cable damage
- Flat head, also for temporary installation for preliminary work
- The flat head means the cable tie sits tightly
- With plastic tongue/tab

TECHNICAL DATA:

- Polyamide 6.6, halogen-free
- UL approval 94, Class HB
- The addition of carbon means that the cable tie is UV-resistant to EN ISO 4890 (corresponds to approx. 3 years of sunlight)
- Application temperature: -45 °C to +85 °C
- Mounting temperature: -30 °C to +60 °C
- Melting point: 256 °C

Flat head cable tie (OZ077)

With plastic tongue/lug, according to DIN EN 50164. The addition of carbon means that the cable tie is UV-resistant to EN ISO 4890 (corresponds to approx. 3 years of sunlight), oxygen index [LOI]: 22%

Type	Colour	Width	Length	Bundle ø, max.	Thickness	Contents PU	Weight	Shipping box	Item No.
		mm	mm	mm	mm	pcs	kg/PU	PU	
OZ077 9X132	Black	9.00	132.00	27.00	1.00	100	0.23	1	904 59 0
OZ077 9X180	Black	9.00	180.00	40.00	1.00	100	0.35	1	904 59 1



Double flat-head cable tie (OZ077)

With plastic tongue/lug, according to DIN EN 50164. The addition of carbon means that the cable tie is UV-resistant to EN ISO 4890 (corresponds to approx. 3 years of sunlight), oxygen index [LOI]: 22%

Type	Colour	Width	Length	Bundle ø, max.	Thickness	Contents PU	Weight	Shipping box	Item No.
		mm	mm	mm	mm	pcs	kg/PU	PU	
OZ077 9X260	Black	9.00	26.00	27.00	1.00	100	0.58	1	904 59 2
OZ077 9X360	Black	9.00	360.00	40.00	1.00	100	0.77	1	904 59 3



Fastening tie and accessories

CHARACTERISTIC:

- Internal toothing
- With plastic tongue/tab
- Minimum retaining force: 360 N
- Fastening using anchor and screw M6/M7

TECHNICAL DATA:

- Polyamide 6.6, halogen-free
- UL approval 94, Class V2
- Application temperature: -40 °C to +85 °C
- Mounting temperature: -15 °C to +60 °C
- Colour grey (RAL7035)



Fastening tie, screw-on (OZ073)

For quick and flexible fastening of pipes or cables with an integrated cable tie. Attachment using M7 thread or appropriate screw.

Polyamide

Type	Colour	Width mm	Length mm	Bundle \varnothing , max. mm	Thickness mm	Contents PU pcs	Weight kg/PU	Shipping box PU	Item No.
OZ073 16-32	Grey	7.50	180.00	32.00	1.45	100	0.60	1	991 50 5
OZ073 40-63	Grey	7.50	280.00	63.00	1.45	100	0.90	1	991 50 7



Push-fit anchor for fastening tie M6/M7 (PG037)

Push-fit anchor for \varnothing 8 mm drill hole.

With M7 thread for fastening to fastening tie, incl. base (OZ073).

Polyamide

Type	Colour	Dimension	Contents PU pcs	Weight kg/PU	Shipping box PU	Item No.
PG037 M7 10x43	Grey	10x37	100	0.20	1	991 53 0



Speedplug SPM M7, countersunk collar, countersunk head

Nail anchor for electrical engineers and sanitary installation engineers for clip fastening using an M7 thread.

Polyamide

Type	Colour	Dowel \varnothing mm	Anchor length mm	Thread size M	Thread increase mm	Contents PU pcs	Weight kg/PU	Shipping box PU	Item No.
SPM 7/1,5 6x40	Natural	6.00	40.00	7.00	1.50	200	1.40	10	962 69 0

CHARACTERISTIC:

- Suitable for use with Fixpin
- Length: 10 m

Metal installation strap, straight (MZ023)

To fasten pipes on concrete.

Steel Galvanised

Type	Width mm	Height mm	Length mm	Hole- Ø mm	Contents PU pcs	Weight kg/PU	Shipping box PU	Item No.
MZ023 12x0,75	12.00	0.75	10,000.00	5.20	1	0.54	10	900 92 5
MZ023 17x0,75	17.00	0.75	10,000.00	6.50	1	0.96	10	900 93 6
MZ023 25x0,75	25.00	0.75	10,000.00	8.50	1	1.30	10	900 94 8



Metal installation strap, straight, in plastic cassette (MZ029)

To fasten pipes on concrete.

Steel Galvanised

Type	Width mm	Height mm	Length mm	Hole- Ø mm	Contents PU pcs	Weight kg/PU	Shipping box PU	Item No.
MZ029 12x0,75	12.00	0.75	10,000.00	5.10	1	0.55	10	900 92 7
MZ029 17x0,75	17.00	0.75	10,000.00	6.50	1	0.93	10	900 93 4
MZ029 25x0,75	25.00	0.75	10,000.00	8.50	1	1.40	10	900 93 5



Metal installation strap, plastic-covered (MZ024)

To fasten pipes and cables on concrete.

Steel Galvanised

Type	Colour	Width mm	Height mm	Length mm	Hole- Ø mm	Contents PU pcs	Weight kg/PU	Shipping box PU	Item No.
MZ024 14x3	Black	14.00	3.00	10,000.00	5.20	1	0.67	10	900 92 6
MZ024 19x2	Black	19.00	2.00	10,000.00	6.50	1	1.10	10	900 93 7
MZ024 27x3	Black	27.00	3.00	10,000.00	8.50	1	1.40	10	900 94 7



Metal installation strap, plastic-covered, in box (MZ030)

To fasten pipes and cables on concrete.

Steel Galvanised

Type	Colour	Width mm	Height mm	Length mm	Hole- Ø mm	Contents PU pcs	Weight kg/PU	Shipping box PU	Item No.
MZ030 19x2	Black	19.00	2.00	10,000.00	6.50	1	1.23	10	900 93 8
MZ030 14x3	Black	14.00	3.00	10,000.00	5.20	1	0.82	10	900 94 0



Installation strap, plastic

CHARACTERISTIC:

- Suitable for fastening with Fixpin or other nails and screws
- Versatile use as tear-resistant
- High-quality polypropylene (PP), UV-stabilised



Woven tape, plastic, black (MZ027)

To fasten pipes and cables on concrete.
Polypropylene

Type	Colour	Width mm	Height mm	Length mm	Contents PU pcs	Weight kg/PU	Shipping box PU	Item No.
MZ027 15x1,3	Black	15.00	1.30	15,000.00	1	0.10	115	900 92 8



Woven tape, plastic, grey (MZ027)

To fasten pipes and cables on concrete.
Polypropylene

Type	Colour	Width mm	Height mm	Length mm	Contents PU pcs	Weight kg/PU	Shipping box PU	Item No.
MZ027 15x1,3	Grey	15.00	1.30	10,000.00	234	0.07	1	900 95 5
MZ027 15x1,3	Grey	15.00	1.30	25,000.00	92	0.18	1	900 95 6



Cassette, woven tape, plastic (MZ030)

Plastic cassette for woven tape up to 15 m.
The woven tape is not supplied!
Polypropylene

Type	Colour	Width mm	Height mm	Length mm	Hole- Ø mm	Contents PU pcs	Weight kg/PU	Shipping box PU	Item No.
MZ030 15	Black	—	—	—	—	1	0.09	1	900 93 9

CHARACTERISTIC:

- For all standard insulation work in the electrical field
- Can also be used universally as colour coding or for bundling
- High-quality soft PVC film
- Best results are achieved at a processing temperature of 20 and 24 °C

Insulating tape, electrical, standard (EM027)

Suitable for all standard insulation work in the electrical field. It can also be used universally for repairs, colour-coding and bundling.

Polyvinylchloride

Type	Colour	Width mm	Material thickness mm	Length mm	Contents PU pcs	Weight kg/PU	Shipping box PU	Item No.
EM027 15x10	Black	15.00	0.15	10,000.00	20	0.06	12	942 00 0
EM027 15x10	Red	15.00	0.15	10,000.00	20	0.06	12	942 00 1
EM027 15x10	Blue	15.00	0.15	10,000.00	20	0.06	12	942 00 2
EM027 15x10	Brown	15.00	0.15	10,000.00	20	0.06	12	942 00 3
EM027 15x10	Yellow green	15.00	0.15	10,000.00	20	0.06	12	942 00 4



Insulating tape, electrical, weatherproof (EM028)

Particularly suitable for insulation and repair work during good weather conditions.

Type	Colour	Width mm	Material thickness mm	Length mm	Contents PU pcs	Weight kg/PU	Shipping box PU	Item No.
EM028 15x10W	Black	15.00	0.20	10,000.00	10	0.69	10	942 00 5



Insulating tape

CHARACTERISTIC, self-sealing natural rubber adhesive tape:

- Quick sealing on overlapping under tension
- Watertight, permanently elastic and very malleable

CHARACTERISTIC, double-sided woven adhesive tape:

- Double-sided viscose woven tape with strong adhesive
- Satisfies requirements according to DIN EN 60454-2
- Carrier material is air-permeable

CHARACTERISTIC, PTFE thread sealing tape:

- Usable for fine weights (FRp)
- Lubricating, sealing and operating material for gas and water installation
- DIN-DVGW test mark according to NV 5143 available



IIR

Natural rubber adhesive tape, self-sealing (EM029)

Suitable for all electrical installation and repair work.

Type	Colour	Width mm	Material thickness mm	Length mm	Contents PU pcs	Weight kg/PU	Shipping box PU	Item No.
EM029 19x5	Black	15.00	1.00	5,000.00	5	0.60	25	942 00 6



VISKOSE

Viscose adhesive tape, double-sided (EM030)

Suitable for the mounting of cable sleeves and for the repair of damaged cable jacketing. Also used to seal hoses and cables.

Type	Colour	Width mm	Material thickness mm	Length mm	Contents PU pcs	Weight kg/PU	Shipping box PU	Item No.
EM030 45x25	Black	45.00	0.30	25,000.00	10	3.86	1	942 00 7



PTFE

PTFE thread sealing tape (EM031)

The Teflon woven sealing tape is suitable for sealing pipe glands.

Type	Colour	Width mm	Contents PU pcs	Weight kg/PU	Shipping box PU	Item No.
EM031 12x12	White	12.00	10	0.18	10	942 00 8

CHARACTERISTIC:

- Chain according to DIN 5686, not tested

Knotted chain (MZ050)

For the suspension of elements such as lighting and signs

Steel Electrogalvanised

Type	Dimension	Contents PU pcs	Weight kg/PU	Shipping box PU	Item No.
MZ050 2,0x28	2.0 x 28	1	2.40	1	981 67 0
MZ050 2,5x35	2.5 x 35	1	4.20	1	981 67 1
MZ050 3,1x41	3.1 x 41	1	6.00	1	981 67 2



S hook (MZ051)

Can be used in conjunction with chains

Steel Electrogalvanised

Type	Dimension	Contents PU pcs	Weight kg/PU	Shipping box PU	Item No.
MZ051 3,0x25	3.0 x 25	100	0.47	10	981 67 3



Flattener

APPLICATION:

- **Fixpin flattener with hand protection (black grip)**
Suitable for knocking in Fixpin (not suitable for breakable Fixpin)
- **Fixpin flattener with hand protection (red grip)**
Suitable for breakable Fixpin
- **M6 flattener (without grip)**
Suitable for M6 knock-in anchors

CHARACTERISTIC:

- For use with 1 kg hammer
- Manufactured from tool steel of very high quality (corresponds to DIN 7255 safety standard)



Flattener with hand protection (KS207)

For knocking in a Fixpin with \varnothing 4 mm. The flattener with a black grip is not suitable for breakable Fixpins.
Steel Electrogalvanised

Type	Colour	Dimension	Contents PU pcs	Weight kg/PU	Shipping box PU	Item No.
KS207 4	Black	4	1	0.49	1	903 00 9



Flattener with hand protection for breakable Fixpin (KS246)

For knocking in a Fixpin with \varnothing 4 mm. The flattener with a red grip is only suitable for breakable Fixpins.
Steel Electrogalvanised

Type	Colour	Dimension	Contents PU pcs	Weight kg/PU	Shipping box PU	Item No.
KS246 4	Red	4	1	0.53	1	903 01 0



Flattener without hand protection (KS170)

Item 903512:
For knocking in M6 anchors, painted red.
The red colour allows easy detection of the grip area.
The unpainted end contains the 10 mm-deep seat for the head of the M6 knock-in anchor.

Item 903516:
Not painted.
Steel Electrogalvanised

Type	Colour	Dimension	Contents PU pcs	Weight kg/PU	Shipping box PU	Item No.
KS170 M6	Red	M6	1	0.15	1	903 51 2
KS170 M6	—	M6	1	0.16	1	903 51 6

Flattener without hand protection with slot (KS221)

For knocking in for anchors with M6 thread.
Depth of the seat: 20 mm plus slot.

Steel Electrogalvanised

Type	Colour	Dimension	Contents PU pcs	Weight kg/PU	Shipping box PU	Item No.
KS221 M6	–	M6	1	0.16	1	903 51 8



Cable tie pliers

CHARACTERISTIC:

- Robust metal housing
- Ergonomic design
- Process-safe clamping

2 Versions

- Each version with automatic cutting for plastic cable ties of widths between 2.2 and 4.8 mm
- Including adjustable tightening tension or with manual cutting for plastic cable ties of widths between 3.6 and 13 mm
- With cutting button for controlled cutting



Cable tie pliers, automatic cut-off (OZ068)

For automatic tensioning and cutting of cable ties with max. width 5 mm.

Steel

Type	Colour	Dimension	Contents PU pcs	Weight kg/PU	Shipping box PU	Item No.
OZ068	Red	2.2 - 4.8	1	0.31	1	903 60 1



Cable tie pliers, manual cut-off (OZ069)

For simple tensioning and cutting of cable ties with max. width 13 mm.

Steel

Type	Colour	Dimension	Contents PU pcs	Weight kg/PU	Shipping box PU	Item No.
OZ069	Red	3.6 - 13	1	0.26	1	903 60 0



Connecting and distributing, e.g. of our junction boxes and screwless terminals

2 Connecting and distributing

Junction box	74
Terminal	76
Sleeve	81
Heat-shrinkable sleeve	82
Accessories for concealed mounting	86

Junction box, damp-proof IP54, without terminal block

CHARACTERISTIC:

- Surface-mounted box for easy mounting
- Can be used indoors and outdoors
- With fastening straps at the sides
- Self-sealing entries
- Protection rating IP 54
- Flame-resistant according to VDE and DIN

TECHNICAL DATA:

- Nominal cross-section: 2.5 mm²
- *Junction box 7:*
 - 7 entries for cable ø 8–14 mm
- *Junction box 10:*
 - 6 entries for cable ø 7–14 mm, 4 entries for cable ø 7–9 mm
- *Junction box 12:*
 - 12 entries for cable ø 8–14 mm
- *Junction box 20:*
 - 8 entries for cable ø 7–14 mm, 8 entries for cable ø 7–11 mm



Junction box 7 (EM10)

For quick and safe installation of all current cables.

Polypropylene

Type	Colour	Dimension B x L x S mm	No. of entries	Contents PU pcs	Weight kg/PU	Shipping box PU	Item No.
EM10 7	Grey	75 x 75 x 36.2	7.00	10	0.36	5	904 34 3



Junction box 10 (EM009)

For quick and safe installation of all current cables.

Polypropylene

Type	Colour	Dimension B x L x S mm	No. of entries	Contents PU pcs	Weight kg/PU	Shipping box PU	Item No.
EM009 10	Grey	80 x 43 x 36.2	10.00	10	0.35	15	904 34 4



Junction box, damp-proof IP54, without terminal block

Junction box 12 (EM011)

For quick and safe installation of all current cables.

Polypropylene

Type	Colour	Dimension B x L x S mm	No. of entries	Contents PU pcs	Weight kg/PU	Shipping box PU	Item No.
EM011 12	Grey	85 x 85 x 40	12.00	10	0.48	8	904 34 5



Junction box 16 (EM020)

For quick and safe installation of all current cables.

Polyamide

Type	Colour	Dimension B x L x S mm	No. of entries	Contents PU pcs	Weight kg/PU	Shipping box PU	Item No.
EM020 16	Grey	100 x 100 x 40	16.00	10	0.58	1	992 27 9



Luster terminal (screw terminal)

CHARACTERISTIC:

- 12-pin bars
- Simply twist to separate into the single terminals
- Screws made of electrogalvanised steel
- Captive, raised screws
- Steel terminals
- Suitable for (rigid) single-wire and multi-wire conductors



Lamp-wire connector (EM003 to EM006)

For conductor connection in boxes, junction boxes, canopies or renovation sockets.

Polypropylene

Type	Colour	Nominal cross section mm ²	Nominal current A	Dimension	Contents PU pcs	Weight kg/PU	Shipping box PU	Item No.
EM003 4x12 pol	White	1.00-4.00	32.00	4x12	10	0.18	50	904 33 6
EM004 6x12 pol	White	0.50-6.00	41.00	6x12	10	0.26	50	904 33 7
EM005 10x12 pol	White	0.50-10.00	57.00	10x12	10	0.43	25	904 33 8
EM006 16x12 pol	White	6.00-16.00	76.00	16x12	10	0.75	10	904 33 9



CHARACTERISTIC:

- 12-pin bars
- Can be separated in single terminals
- Steel screw, electrogalvanised
- Brass terminals
- Suitable for (rigid) single-wire and multi-wire conductors
- Ideal for use in concealed or surface-mounted boxes
- Available in versions open on one or both sides

TECHNICAL DATA:

- Nominal cross-section: max. 4 x 2.5 mm², 5 x 1.5 mm² or 6 x 1 mm²

Box lamp-wire connector, open on both sides (EM008)

For conductor connection in boxes, junction boxes or canopies.

Polyamide

Type	Colour	Nominal cross section mm ²	Nominal current A	Dimension	Contents PU pcs	Weight kg/PU	Shipping box PU	Item No.
EM008 2,5x12 pol	sorted	1.00-2.50	16.00	2.5x12	10	0.26	18	904 34 0

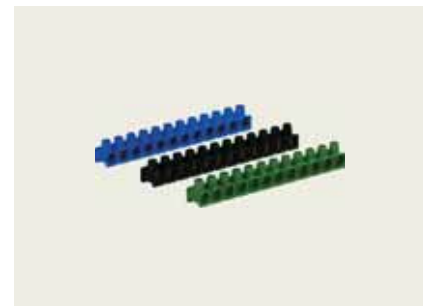

Box lamp-wire connector, open on one side (EM008)

For conductor connection in boxes, junction boxes or canopies.

Polyamide

Type	Colour	Nominal cross section mm ²	Nominal current A	Dimension	Contents PU pcs	Weight kg/PU	Shipping box PU	Item No.
EM008 2,5x12 pol	Black	1.00-2.50	20.00	2.5x12	10	0.26	40	904 34 1



Screwless terminal (spring type terminal)

CHARACTERISTIC:

- Screwless connection terminal to connect rigid single-wire or multi-wire cables
- Low insertion force
- Multiple wire cross-sections can be inserted into a terminal
- High extraction force
- Transparent sight glass for visual check increases safety during mounting
- Turning the cable loosens the connection again

TECHNICAL DATA:

Suitable for:

- Rigid, single-wire conductor between 0.5 and 2.5 mm²
- Rigid, multi-wire conductor between 1.5 and 2.5 mm²
- Nominal voltage 450 V
- Nominal current 24 A
- Stripping length: 8–9 mm

Screwless terminal, 3-pin (EM001)

For conductor connection in boxes, junction boxes, canopies or renovation sockets.

Polyamide



Type	Colour	Nominal cross section mm ²	Nominal current A	Dimension	Contents PU pcs	Weight kg/PU	Shipping box PU	Item No.
EM001 0,5-2,5x3	Grey	0.50-2.50	24.00	0.5 - 2.5 x 3	100	0.72	20	904 33 2



Screwless terminal, 5-pin (EM002)

For conductor connection in boxes, junction boxes, canopies or renovation sockets.

Polyamide



Type	Colour	Nominal cross section mm ²	Nominal current A	Dimension	Contents PU pcs	Weight kg/PU	Shipping box PU	Item No.
EM002 0,5-2,5x5	Grey	0.50-2.50	24.00	0.5-2.5x5	100	0.30	20	904 33 3



Cutting terminals

The fast ones for two or three connections



Seven reasons for rapid connecting and distributing:

1. No screwing or soldering required
2. Voltage to max. 600 V
3. Brass contact elements
4. Insulation material made of polycarbonate
Temperature: -40 °C to + 80 °C
- Combustion class of the insulation material according to UL 94: V2
5. T shape allows rapid arresting without cable disconnection
6. I shape allows extension without stripping
7. I shape for 2 connections, T shape for 3 connections

Crimp clamp

CHARACTERISTIC:

- I type for cable extension (2 connections)
- T type for simple branching without needing to disconnect the existing cable (3 connections)
- Simply insert the unstripped cable and clamp it – and you're done! - No cable stripping
- No screwing or soldering required
- Suitable for (rigid) single-wire and multi-wire conductors

TECHNICAL DATA:

- Max. voltage 600 V
- Temperature range: -40 °C to 80 °C
- Brass contact elements
- Insulation material made of polycarbonate (PC)
- Combustion class of the insulation material: UL 94:V2



Crimp clamp, I type (EM022)

For rapid connection of single-wire, multi-wire and fine-wire conductors without wire end sleeve.
Polycarbonate

Type	Colour	Nominal cross section mm ²	Nominal current A	Contents PU pcs	Weight kg/PU	Shipping box PU	Item No.
EM022 I-1 0,2-0,5	Grey	0.20-0.50	3.00	100	0.08	1	904 25 0
EM022 I-2 0,6-1,0	Grey	0.60-1.00	10.00	100	0.10	1	904 25 1
EM022 I-3 1,25-2,0	Grey	1.25-2.00	15.00	100	0.14	1	904 25 2
EM022 I-4 2,25-3,0	Grey	2.25-3.00	20.00	100	0.20	1	904 25 3
EM022 I-5 3,25-5,0	Grey	3.25-5.00	30.00	100	0.25	1	904 25 4



Crimp clamp, T type (EM022)

For rapid connection of single-wire, multi-wire and fine-wire conductors without wire end sleeve.
Branch of an existing cable without cut-off.
Polycarbonate

Type	Colour	Nominal cross section mm ²	Nominal current A	Contents PU pcs	Weight kg/PU	Shipping box PU	Item No.
EM022 T-1 0,2-0,5	Grey	0.25-0.50	3.00	100	0.10	1	904 26 0
EM022 T-2 0,6-1,0	Grey	0.60-1.00	10.00	100	0.12	1	904 26 1
EM022 T-3 1,25-2,0	Grey	1.25-2.00	15.00	100	0.18	1	904 26 2
EM022 T-4 2,25-3,0	Grey	2.25-3.00	20.00	100	0.25	1	904 26 3
EM022 T-5 3,25-5,0	Grey	3.25-5.00	30.00	100	0.35	1	904 26 4

Empty pipe sleeve with click-connection

CHARACTERISTIC:

- Connection sleeve for flexible/flexible empty pipe or flexible/rigid empty pipe
- Simple mounting thanks to sleeve open at the side
- Without tools, simply close "single-handedly" with a click

TECHNICAL DATA:

- Plastic, halogen and silicone-free
- Melting temperature of 165/168 °C according to ISO 11357-3
- Flame-resistant to UL94 V2
- Glow wire test acc. to IEC 60695-2-12, test temperature 960 °C

Empty pipe sleeve "Connect-Ring" (OZ056)

Tension-resistant connection of all empty pipe types (rigid/flexible, flexible/flexible)

Polypropylene

Type	Colour	Thread size M	Smallest sales unit	Contents PU pcs	Weight kg/PU	Shipping box PU	Item No.
OZ056 M16	Grey	16.00	1.00	50	0.40	16	900 96 1
OZ056 M20	Grey	20.00	1.00	50	0.46	16	900 96 5
OZ056 M25	Grey	25.00	1.00	40	0.46	16	900 96 9
OZ056 M32	Grey	32.00	1.00	20	0.37	16	900 97 1



Heat-shrinkable sleeve 2:1 / 3:1, thin-walled

TECHNICAL DATA:

- Material: Polyolefin, cadmium-free
- Self-extinguishing acc. to UL224, test temperature +125 °C
- Shrink temperature: > +90 °C
- Application temperature: -55 °C to +135 °C

Shrink rate	Inner ø before shrink [mm]	Inner ø after shrink [mm]	Nominal ø in inches	Wall thickness after shrink [mm]
2:1	1.2	0.6	3/64	0.41
2:1	1.6	0.8	1/16	0.43
2:1	2.4	1.2	3/32	0.51
2:1	3.2	1.6	1/8	0.51
2:1	4.8	2.4	3/16	0.51
2:1	6.4	3.2	1/4	0.64
2:1	9.5	4.7	3/8	0.64
2:1	12.7	6.4	1/2	0.64
2:1	19.1	9.5	3/4	0.77
2:1	25.4	12.7	1	0.89
2:1	38.1	19.1	1 1/2	1.02
2:1	50.8	25.4	2	1.14
3:1	1.5	0.5		0.45
3:1	3.0	1.0		0.55
3:1	4.8	1.6		0.60
3:1	6.0	2.0		0.70
3:1	9.0	3.0		0.70
3:1	12.0	4.0		0.70
3:1	18.0	6.0		0.80
3:1	24.0	8.0		1.00
3:1	39.0	13.0		1.15



2:1 heat-shrinkable sleeve, thin-walled, in dispensing box (OZ071)

Used in many different areas, such electrical insulation, cable bundling, strain relief or identification.

Type	Colour	Inner diameter before shrink mm	Contents PU pcs	Weight kg/PU	Shipping box PU	Item No.
OZ071 3-64	Black	1.20	1	0.11	1	905 52 0
OZ071 1-16	Black	1.60	1	0.12	1	905 52 1
OZ071 3-32	Black	2.40	1	0.14	1	905 52 2
OZ071 1-8	Black	3.20	1	0.16	1	905 52 3
OZ071 3-16	Black	4.80	1	0.17	1	905 52 4
OZ071 1-4	Black	6.40	1	0.22	1	905 52 5
OZ071 3-8	Black	9.50	1	0.24	1	905 52 6
OZ071 1-2	Black	12.70	1	0.24	1	905 52 7
OZ071 3-4	Black	19.10	1	0.26	1	905 52 9
OZ071 1	Black	25.40	1	0.36	1	905 54 7
OZ071 3-32	Red	2.40	1	0.36	1	905 51 3
OZ071 1-8	Red	3.20	1	0.38	1	905 51 4
OZ071 3-16	Red	4.80	1	0.34	1	905 51 5
OZ071 1-4	Red	6.40	1	0.44	1	905 51 6
OZ071 1-2	Red	12.70	1	0.46	1	905 51 8
OZ071 3-4	Red	19.10	1	0.48	1	905 51 9
OZ071 3-8	Red	9.50	1	0.46	1	905 51 7

Heat-shrinkable sleeve 2:1 / 3:1, thin-walled

2:1 heat-shrinkable sleeve, thin-walled, black/yellow-green, in assorted box (OZ072)

Used in many different areas, such electrical insulation, cable bundling, strain relief or identification.

Type	Colour	Inner diameter before shrink	Contents PU	Weight	Shipping box	Item No.
		mm	pcs	kg/PU	PU	
OZ071 BOX	–	–	1	0.36	1	905 77 2



Contents

Size [mm]	Length [mm]	Colour	Quantity
1.20	50	Black	40
1.20	50	Yellow-green	30
1.60	50	Black	40
1.60	50	Yellow-green	30
2.40	50	Black	35
2.40	50	Yellow-green	30
3.20	50	Black	25
3.20	50	Yellow-green	25
4.80	50	Black	20
4.80	50	Yellow-green	15
6.40	50	Black	12
6.40	50	Yellow-green	12
9.5	50	Black	12
9.5	50	Black	12
9.5	50	Yellow-green	12
9.5	50	Yellow-green	12
12.7	100	Black	7
19.10	200	Black	6

2:1 heat-shrinkable sleeve, thin-walled, black/coloured, in assorted box (OZ071)

Used in many different areas, such electrical insulation, cable bundling, strain relief or identification.

Type	Colour	Inner diameter before shrink	Contents PU	Weight	Shipping box	Item No.
		mm	pcs	kg/PU	PU	
OZ071 BOX	–	–	406	0.39	1	905 57 4



Contents

Size [mm]	Length [mm]	Colour	Quantity
1.20	50	Black	25
1.20	50	Brown	25
1.20	50	Blue	25
1.60	50	Black	25
1.60	50	Brown	25
1.60	50	Red	25
2.40	50	Black	20
2.40	50	Brown	20
2.40	50	Grey	20
3.20	50	Black	50
4.80	50	Black	40
6.40	50	Black	15
6.40	50	Grey	15
9.5	50	Black	15
9.5	50	Red	15
9.5	50	Yellow-green	15
9.5	50	Blue	15
12.7	100	Black	10
19.10	200	Black	6

Heat-shrinkable sleeve 2:1 / 3:1, thin-walled



3:1 heat-shrinkable sleeve, thin-walled, 1 m long (OZ070)

Used in many different areas, such electrical insulation, cable bundling, strain relief or identification.

Type	Colour	Inner diameter before shrink		Contents PU	Weight	Shipping box	Item No.
		mm		pcs	kg/PU	PU	
OZ070 1,5-0,5	Black	1.50		50	0.10	1	905 54 8
OZ070 3-1	Black	3.00		50	0.21	1	905 54 9
OZ070 9-3	Black	9.00		25	0.32	1	905 56 1
OZ070 18-6	Black	18.00		25	0.77	1	905 56 2



3:1 heat-shrinkable sleeve, thin-walled, black/coloured, in assorted box (OZ072)

Used in many different areas, such electrical insulation, cable bundling, strain relief or identification.

Type	Colour	Inner diameter before shrink		Contents PU	Weight	Shipping box	Item No.
		mm		pcs	kg/PU	PU	
OZ071 BOX	—	—		170	0.58	1	905 57 3

Contents

Size [mm]	Length [mm]	Colour	Quantity
1.5/0.5	40	Black	10
1.5/0.5	40	Red	5
1.5/0.5	40	Blue	5
1.5/0.5	40	Yellow-green	5
1.5/0.5	40	Brown	5
3/1	40	Black	20
3/1	40	Red	5
3/1	40	Blue	5
3/1	40	Yellow-green	5
3/1	40	Brown	5
6/2	40	Black	20
6/2	40	Red	5
6/2	40	Blue	5
6/2	40	Yellow-green	5
6/2	40	Brown	5
9/3	80	Black	5
9/3	80	Red	2
9/3	80	Blue	2
9/3	80	Yellow-green	2
9/3	80	Brown	2
12/4	80	Black	10
12/4	80	Red	2
12/4	80	Blue	2
12/4	80	Yellow-green	2
12/4	80	Brown	2
18/6	120	Black	10
18/6	80	Red	2
18/6	80	Blue	2
18/6	80	Yellow-green	2
18/6	80	Brown	2
24/8	170	Black	8
24/8	120	Red	2
24/8	120	Blue	2
24/8	120	Yellow-green	2
24/8	120	Brown	2

Heat-shrinkable sleeve 3:1 / 4:1, double-walled

CHARACTERISTIC:

- Double-walled, incl. interior adhesive
- The thermoplastic adhesive melts, thus sealing the inner components
- Offers excellent insulation against moisture
- Good adhesion on steel and plastics

TECHNICAL DATA:

- Material: Polyolefine, cadmium-free
- Heat-shrinkable sleeve, self-extinguishing acc. to UL224, test temperature +125 °C
- Shrink temperature: > +110 °C
- Application temperature: -55 °C to +110 °C

Shrink rate	Inner ø before shrink [mm]	Inner ø after shrink [mm]	Wall thickness after shrink [mm]
3:1	3.0	1.0	1.00
3:1	4.8	1.6	1.00
3:1	6.0	2.0	1.10
3:1	9.0	3.0	1.30
3:1	12.0	4.0	1.70
3:1	18.0	6.0	2.00
3:1	24.0	8.0	2.50
4:1	52.0	13.0	2.50

3:1 heat-shrinkable sleeve, double-walled, 1 m long (OZ070)

Used in many different areas, such electrical insulation, cable bundling, strain relief or identification.

Type	Colour	Inner diameter before shrink mm	Contents PU pcs	Weight kg/PU	Shipping box PU	Item No.
OZ070 3-1	Black	3.00	50	0.44	1	905 50 5
OZ070 4,8-1,6	Black	4.80	50	0.64	1	905 50 6
OZ070 6-2	Black	6.00	25	0.34	1	905 50 7
OZ070 9-3	Black	9.00	25	0.66	1	905 50 8
OZ070 12-4	Black	12.00	25	0.82	1	905 50 9
OZ070 24-8	Black	24.00	15	1.44	1	905 51 1
OZ070 39-13	Black	39.00	10	1.62	1	905 51 2
OZ070 18-6	Black	18.00	25	1.58	1	905 51 0



4:1 heat-shrinkable sleeve, double-walled, 1 m long (OZ070)

Used in many different areas, such electrical insulation, cable bundling, strain relief or identification.

Type	Colour	Inner diameter before shrink mm	Contents PU pcs	Weight kg/PU	Shipping box PU	Item No.
OZ070 52-13	Black	52.00	10	1.20	1	905 50 4



Accessories for concealed mounting

CHARACTERISTIC:

- Seat, M16 thread
- All segments are laser-welded
- Very good tool lives (long lifespan with low wear) through optimised segment structure
- In 3 versions per area of use

Diamond dry core drill UNIT (GE001)

For soft to medium-hard calcareous sandstone.

Low-cost introduction into the world of quality diamond dry-core drills for light to medium-difficulty applications.

Type	Colour	Diameter	Contents PU	Weight	Shipping box	Item No.
		mm	pcs	kg/PU	PU	
GE001 UNI68	Red	68.00	1	0.49	1	998 15 0
GE001 UNI82	Red	82.00	1	0.57	1	998 15 1

Diamond dry core drill PREMIUM (GE002)

For hard calcareous limestone, Quadro block, masonry, brickwork, clinker and, in some cases, concrete.

With special segmentation for optimum cooling.

Type	Colour	Diameter	Contents PU	Weight	Shipping box	Item No.
		mm	pcs	kg/PU	PU	
GE002 NRS68	Green	68.00	1	0.47	1	998 15 2
GE002 NRS82	Green	82.00	1	0.54	1	998 15 3

Diamond dry core drill MATRIX (GE003)

For hard calcareous limestone, Quadro block, masonry, brickwork, clinker and, in some cases, concrete.

With 3-D segmentation for faster drilling speed and improved retention.

Suitable for suction device (low-dust working).

70 mm drilling depth for simple wiring behind the box.

Type	Colour	Diameter	Contents PU	Weight	Shipping box	Item No.
		mm	pcs	kg/PU	PU	
GE003 M68	White	68.00	1	0.51	1	998 15 5
GE003 M82	White	82.00	1	0.58	1	998 15 4

CHARACTERISTIC:

- Optimum accessories for the use of the diamond dry core drills
- The use of the suction unit increases the lifespan of the dry core drill, construction site cleaning becomes easier and, according to the insurers, its use reduces the level of workplace illness due to dust
- The suction unit is suitable for the MATRIX dry core drill

Suction unit (GE004)

For low-dust working on walls.

Suction unit suitable for M68 and M82.
Connection possible to any standard fine particle vacuum.
Connection: M18 interior (machine) – M16 exterior (dry core drill)

Type	Colour	Dimension	Contents PU pcs	Weight kg/PU	Shipping box PU	Item No.
GE004	Black	68-82	1	0.37	1	998 15 6



Centring tip for suction unit (GE005)

To centre the drill hole, particularly for suction unit
(After drilling, remove from the suction unit)

Type	Colour	Dimension	Contents PU pcs	Weight kg/PU	Shipping box PU	Item No.
GE005	–	–	1	0.05	1	998 15 7



Support shaft, hexagonal (GE006)

Hexagonal seat for M16 thread

Type	Length of external dimensions mm	Thread size M	Dimension	Contents PU pcs	Weight kg/PU	Shipping box PU	Item No.
GE006	100.00	16.00	6 edges	1	0.11	1	998 15 8



Support shaft SDS+ (GE007)

SDS+ seat for M16 thread

Type	Length of external dimensions mm	Thread size M	Dimension	Contents PU pcs	Weight kg/PU	Shipping box PU	Item No.
GE007	105.00	16.00	SDS+	1	0.10	1	998 15 9



Accessories for concealed mounting

Adapter M18 - M16 (GE008)



Adapter to accept M16 diamond dry core drill on M18 electrical devices.

Type	Colour	Dimension	Contents PU pcs	Weight kg/PU	Shipping box PU	Item No.
GE008	—	M18 to M16	1	0.17	1	998 16 0

Centring drill (GE009)



Suitable for support shaft GE006 and GE007.

Type	Colour	Dimension	Contents PU pcs	Weight kg/PU	Shipping box PU	Item No.
GE009	—	—	1	0.04	1	998 16 1

Centring drill, conical (GE010)



Suitable for adapter M18-M16 GE008.

Type	Colour	Dimension	Contents PU pcs	Weight kg/PU	Shipping box PU	Item No.
GE010	—	—	1	0.04	1	998 16 2

CHARACTERISTIC:

- Optimised, laser-welded segments for the greatest possible cooling and long lifespan
- In three versions per area of use

Diamond cutting disc UNI (GE011)

For use in concrete and masonry.

With 9 mm laser-welded segments.

Type	Colour	Diameter	Contents PU	Weight	Shipping box	Item No.
		mm	pcs	kg/PU	PU	
GE011 115	Red	115.00	1	0.11	1	998 16 3
GE011 125	Red	125.00	1	0.14	1	998 16 4
GE011 150	Red	150.00	1	0.20	1	998 16 5



Diamond cutting disc PREMIUM (GE012)

For use in reinforced concrete, granite, natural stone, washed concrete, plaster, calcareous limestone, masonry and brickwork.

With 12 mm laser-welded segments.

Type	Colour	Diameter	Contents PU	Weight	Shipping box	Item No.
		mm	pcs	kg/PU	PU	
GE012 115	Green	115.00	1	0.13	1	998 16 6
GE012 125	Green	125.00	1	0.15	1	998 16 7
GE012 150	Green	150.00	1	0.21	1	998 16 8



Diamond cutting disc MATRIX (GE013)

For use in concrete, reinforced concrete, Korodur, gneiss, calcareous limestone, masonry, brickwork, industrial screed and Quadro blocks.

With extremely large graining, alternating toothing and cobalt binding.

Type	Colour	Diameter	Contents PU	Weight	Shipping box	Item No.
		mm	pcs	kg/PU	PU	
GE013 115	White	115.00	1	0.12	1	998 16 9
GE013 125	White	125.00	1	0.14	1	998 17 0
GE013 150	White	150.00	1	0.21	1	998 17 1





Routing, e.g. with our grouped supports and clamp clips

3 Routing and guiding

Connector range, hooks and loops	92
Nail clip, clamp clip, pipe clamp	96
Iso pressure and grip clip	114
Fastening clip, plastic, metal	117
Grouped support	129
Clamp strap	133
Profile rail and clamp clip	136

Connection range STD hook

CHARACTERISTIC:

- Rapid fastening
- No screwing
- No knocking-in
- Multiple diameters can be fastened simultaneously using the push-in hook

TECHNICAL DATA:

- Plastic, halogen and silicone-free
- Colour: Grey (RAL7035)
- Temperature resistance:
 - 80 °C, long-term
 - 130 °C, short-term
 - -10 °C during mounting
 - -40 °C during use
- Flame-resistant to UL 84 HB
- UV-resistant. The product can be used under UV-radiation in both dry and warm as well as in humid and warm climates for at least 5 years, without any loss in the use properties



Push-in hook STD (OZ054)

STD is a double hook for fastening one or two cables of 4–12 mm diameter. STD can be inserted into a 6 mm drill hole by hand without tools.

Polyamide

Type	Colour	For cable Ø mm	Bore hole diameter mm	Contents PU pcs	Weight kg/PU	Shipping box PU	Item No.
STD 4x12	Grey	4.00-12.00	6.00	200	0.30	16	954 92 2

CHARACTERISTIC:

- Cables can be fixed quickly through simple insertion in the pre-drilled hole
- For drill hole diameter of 6 or 8 mm, depending on version
- Version with single or double hook

Push-in hook STH \varnothing 6 mm (OZ065)

A push-in hook to fasten a cable or installation pipe of 13–40 mm diameter. The push-in hook can be inserted into a 6 mm drill hole by hand without tools. The product is manufactured from high-quality PE-HD.

Polyethylene

Type	Colour	For cable \varnothing mm	Bore hole diameter mm	Contents PU pcs	Weight kg/PU	Shipping box PU	Item No.
OZ065 16-19	Natural	16.00-19.00	6.00	100	0.39	10	955 11 9
OZ065 20-25	Natural	20.00-25.00	6.00	100	0.49	10	955 12 0



Push-in hook STH \varnothing 8 mm (OZ078)

Polyamide

Type	Colour	For cable \varnothing mm	Bore hole diameter mm	Contents PU pcs	Weight kg/PU	Shipping box PU	Item No.
OZ078 16	Grey	16.00	8.00	100	0.68	1	955 12 7
OZ078 20	Grey	20.00	8.00	100	0.74	1	955 12 8



Push-in hook STHD \varnothing 6 mm (OZ064)

A double hook for fastening one or two cables or installation pipes of 13–40 mm diameter. The push-in hook can be inserted into a 6 mm drill hole by hand without tools. The product is manufactured from high-quality PE-HD.

Polyethylene

Type	Colour	For cable \varnothing mm	Bore hole diameter mm	Contents PU pcs	Weight kg/PU	Shipping box PU	Item No.
OZ064 16-19	Natural	16.00-19.00	6.00	100	0.38	10	955 12 1
OZ064 20-24	Natural	20.00-24.00	6.00	100	0.57	10	955 12 2



Connection range STH hook



Push-in hook STHD $\varnothing 8$ mm (OZ078)

Polyamide

Type	Colour	For cable \varnothing mm	Bore hole diameter mm	Contents PU pcs	Weight kg/PU	Shipping box PU	Item No.
OZ078 16	Grey	16.00	8.00	100	0.75	1	955 12 9
OZ078 20	Grey	20.00	8.00	100	1.00	1	955 13 0

CHARACTERISTIC:

- Quick and easy fastening
- High extraction values
- Suitable for stone, concrete, hollow brick, calcareous sandstone and gas concrete
- Drill the hole and simply insert

TECHNICAL DATA:

- Plastic, halogen and silicone-free
- Colour: Grey (RAL7035)
- Temperature resistance:
 - 80 °C, long-term
 - 130 °C, short-term
 - -10 °C during mounting
 - -40 °C during use
- Flame-resistant to UL 84 HB
- UV-resistant. The product can be used under UV-radiation in both dry warm, and humid warm, climates for at least 5 years, without any loss in the use properties

Connecting loop STS, straight (OZ050)

Connecting loop for fastening cables with \varnothing 3 mm to \varnothing 13 mm.
 Drill a 6 mm hole with a depth of 35 mm to 65 mm, depending on the \varnothing and the quantity of cables.
 Insert the connecting loop by hand with tools.
 Strong fastening for cables, individually or bundled.
 To be used in various substrates.

Polyamide

Type	Colour	Bundle \varnothing , max. mm	Contents PU pcs	Weight kg/PU	Shipping box PU	Item No.
STS 13	Grey	13.00	200	0.17	16	932 09 0



Connecting loop STS, curved (OZ050)

Connecting loop for fastening cables with \varnothing 13 mm to \varnothing 40 mm (depending on the type).
 Drill a 6 mm hole with a depth of 35 mm to 65 mm, depending on the \varnothing and the quantity of cables.
 Insert the connecting loop by hand with tools.
 Strong fastening for cables, individually or bundled.
 To be used in various substrates.

Polyamide

Type	Colour	Bundle \varnothing , max. mm	Contents PU pcs	Weight kg/PU	Shipping box PU	Item No.
STS 28	Grey	28.00	100	0.15	12	932 09 1
STS 40	Grey	40.00	50	0.13	12	932 09 2



Nail clamp RKK

CHARACTERISTIC:

- With hardened steel nail for secure fastening in, for example: Concrete
- Colour: White or grey



RKK nail clamp, white (CC001)

For simple cable routing.

Polyethylene

Type	Colour	For cable Ø mm	Shank Ø mm	Nail length mm	Contents PU pcs	Weight kg/PU	Shipping box PU	Item No.
RKK 3x1,2x16	White	3.00	1.20	16.00	100	0.02	20	991 00 2
RKK 4x1,8x16	White	4.00	1.80	16.00	100	0.06	20	991 01 0
RKK 5x1,8x16	White	5.00	1.80	16.00	100	0.05	20	991 02 9
RKK 6x1,8x25	White	6.00	1.80	25.00	100	0.11	10	991 03 7
RKK 7x1,8x25	White	7.00	1.80	25.00	100	0.13	10	991 04 5
RKK 8x1,8x25	White	8.00	1.80	25.00	100	0.10	10	991 05 3



RKK nail clamp, grey (CC001)

For simple cable routing.

Polyethylene

Type	Colour	For cable Ø mm	Shank Ø mm	Nail length mm	Contents PU pcs	Weight kg/PU	Shipping box PU	Item No.
RKK 8x2,0x30	Grey	8.00	2.00	30.00	100	0.10	10	981 45 3
RKK 10x2,0x30	Grey	10.00	2.00	30.00	100	0.20	10	981 48 8
RKK 12x2,0x30	Grey	12.00	2.00	30.00	100	0.23	10	981 49 6
RKK 14x2,5x40	Grey	14.00	2.50	40.00	100	0.29	10	981 50 9
RKK 16x2,5x40	Grey	16.00	2.50	40.00	100	0.48	10	981 51 7
RKK 19x2,5x40	Grey	19.00	2.50	40.00	100	0.53	10	981 53 3

CHARACTERISTIC:

- With hardened steel nail for secure fastening in, for example: Concrete
- One nail clamp for multiple cable diameters
- Available with and without nail
- Colour: Grey (RAL7035)

WKK nail clamp without nail (CC005)

For simple cable routing.
Nail clamp can be used for multiple cable diameters.
Polyethylene

Type	Colour	For cable Ø mm	For nail Ø x l mm	Nail length mm	Contents PU pcs	Weight kg/PU	Shipping box PU	Item No.
WKK 4-7	Grey	4.00-7.00	2	—	100	0.04	90	995 21 4
WKK 7-12	Grey	7.00-12.00	2	—	100	0.06	50	995 21 5
WKK 10-14	Grey	10.00-14.00	2	—	100	0.13	30	995 21 6
WKK 14-17	Grey	14.00-17.00	2	—	100	0.24	18	995 21 9
WKK 17-21	Grey	17.00-21.00	2	—	100	0.34	12	995 22 0



WKK nail clamp with nail (CC006)

For simple cable routing.
Nail clamp can be used for multiple cable diameters.
Polyethylene

Type	Colour	For cable Ø mm	Shank Ø mm	Nail length mm	Contents PU pcs	Weight kg/PU	Shipping box PU	Item No.
WKK 4-7x2,0x18	Grey	4.00-7.00	2.00	18.00	100	0.07	75	991 40 3
WKK 4-7x2,0x25	Grey	4.00-7.00	2.00	25.00	100	0.09	75	990 90 0
WKK 7-12x2,0x18	Grey	7.00-12.00	2.00	18.00	100	0.10	50	990 91 0
WKK 7-12x2,0x25	Grey	7.00-12.00	2.00	25.00	100	0.11	50	990 90 1
WKK 7-12x2,0x35	Grey	7.00-12.00	2.00	35.00	100	0.16	40	990 90 3
WKK 7-12x2,0x45	Grey	7.00-12.00	2.00	45.00	100	0.16	30	990 90 7
WKK 10-14x2,0x25	Grey	10.00-14.00	2.00	25.00	100	0.17	27	990 90 8
WKK 10-14x2,0x30	Grey	10.00-14.00	2.00	30.00	100	0.18	27	990 90 5
WKK 10-14x2,0x40	Grey	10.00-14.00	2.00	40.00	100	0.24	27	990 90 6
WKK 13,5-17x2,0x40	Grey	14.00-17.00	2.00	40.00	100	0.30	10	990 90 9



Nail clamp SKK

CHARACTERISTIC:

- With hardened galvanised steel nail for secure fastening in, for example: Concrete
- Nail clamp made of PE-HD
- A nail clamp for multiple cable diameters
 - 8–10 mm
 - 11–15 mm
 - 16–19 mm
- With KEMA-Keur test mark



SKK nail clamp, grey (CC008)

For simple cable routing.

Polyethylene

Type	Colour	For cable Ø mm	Shank Ø mm	Nail length mm	Pack. PU	Contents PU pcs	Weight kg/PU	Shipping box PU	Item No.
SKK 8-10	Grey	11.00-15.00	2.00	35.00	1.00	100	0.20	1	981 62 3
SKK 11-15	Grey	11.00-15.00	2.00	35.00	1.00	100	0.22	1	981 62 6
SKK 16-19	Grey	11.00-15.00	2.00	35.00	1.00	100	0.32	1	981 62 7



SKK nail clamp, white (CC008)

For simple cable routing.

Polyethylene

Type	Colour	For cable Ø mm	Shank Ø mm	Nail length mm	Pack. PU	Contents PU pcs	Weight kg/PU	Shipping box PU	Item No.
SKK 8-10	White	11.00-15.00	2.00	35.00	1.00	100	0.20	1	981 62 4
SKK 11-15	White	11.00-15.00	2.00	35.00	1.00	100	0.22	1	981 62 5



SKK nail clamp, natural (CC008)

For simple cable routing.

Polyethylene

Type	Colour	For cable Ø mm	Shank Ø mm	Nail length mm	Pack. PU	Contents PU pcs	Weight kg/PU	Shipping box PU	Item No.
SKK 16-19	Natural	16.00-19.00	2.50	40.00	1.00	100	0.32	1	981 62 8

SKK nail clamp, cream (CC008)

For simple cable routing.

Polyethylene

Type	Colour	For cable Ø mm	Shank Ø mm	Nail length mm	Pack. PU	Contents PU pcs	Weight kg/PU	Shipping box PU	Item No.
SKK 16-19	Cream	16.00-19.00	2.50	40.00	1.00	100	0.31	1	981 63 9



SKKD nail clamp, grey (CC009)

For simple cable routing.

Polyethylene

Type	Colour	For cable Ø mm	Shank Ø mm	Nail length mm	Pack. PU	Contents PU pcs	Weight kg/PU	Shipping box PU	Item No.
SKKD 16-19	Grey	16.00-19.00	2.50	40.00	1.00	100	0.44	1	981 62 0



SKKD nail clamp, natural (CC009)

For simple cable routing.

Polyethylene

Type	Colour	For cable Ø mm	Shank Ø mm	Nail length mm	Pack. PU	Contents PU pcs	Weight kg/PU	Shipping box PU	Item No.
SKKD 16-19	Natural	16.00-19.00	2.50	40.00	1.00	100	0.44	1	981 62 1



SKKD nail clamp, cream (CC009)

For simple cable routing.

Polyethylene

Type	Colour	For cable Ø mm	Shank Ø mm	Nail length mm	Pack. PU	Contents PU pcs	Weight kg/PU	Shipping box PU	Item No.
SKKD 16-19	Cream	16.00-19.00	2.50	40.00	1.00	100	0.44	1	981 62 2



Nail clamp SPC

CHARACTERISTIC:

- With hardened galvanised steel nail for secure fastening in, for example: Concrete
- Nail clamp made of PE-HD
- A nail clamp for multiple cable diameters
 - 16–19 mm
- With KEMA-Keur test mark
- Incl. anchor for 6 mm drill hole



SPC nail clamp, natural

For simple cable routing.



SPCD nail clamp, natural

For simple cable routing.

CHARACTERISTIC:

- Rapid cable fastening in masonry slots or on masonry before plastering
- With hardened steel nail
- The cables sit tightly on the masonry
- Optimised shape for use in horizontal and vertical masonry slots

RKS nail disc without nail (KG007)

Plastic disc without pre-mounted nail.
With the RKS nail disc, you can fasten multiple cables in a single step.
Practical in masonry slots and under insulation material.

Polyethylene

Type	Colour	External dimensions mm	For nail Ø x l mm	Contents PU pcs	Weight kg/PU	Shipping box PU	Item No.
RKS 27-34	Natural	27x34	2.0 - 3.3	300	0.33	10	995 22 7



RKS nail disc with nail (KG007)

Plastic disc with pre-mounted nail.
With the RKS nail disc, you can fasten multiple cables in a single step.
Practical in masonry slots and under insulation material.

Polyethylene

Type	Colour	External dimensions mm	Shank Ø mm	Nail length mm	Contents PU pcs	Weight kg/PU	Shipping box PU	Item No.
RKS 27-34x2.0x40	Natural	27x34	2.00	40.00	200	0.43	10	995 22 8
RKS 27-34x2.0x50	Natural	27x34	2.00	50.00	150	0.38	10	995 22 9
RKS 27-34x2.0x60	Natural	27x34	2.00	60.00	150	0.41	10	995 23 0
RKS 27-34x2.5x70	Natural	27x34	2.50	70.00	100	0.43	10	995 23 1
RKS 27-34x3.3x40	Natural	27x34	3.30	40.00	100	0.43	10	995 23 2
RKS 27-34x3.3x50	Natural	27x34	3.30	50.00	100	0.52	10	995 23 3
RKS 27-34x3.3x60	Natural	27x34	3.30	60.00	100	0.59	10	995 23 4



Nail disc KLS

CHARACTERISTIC:

- Rapid cable fastening in masonry slots or on masonry before plastering
- With hardened steel nail
- The cables sit tightly on the masonry
- Round clamping disc
- No alignment required
- Suitable for all masonry slots



KLS nail disc without nail (KG005)

Plastic disc without pre-mounted nail.
With the KLS nail disc, you can fasten multiple cables in a single step.
Practical in masonry slots and under insulation material.

Polypropylene

Type	Colour	For nail Ø x l mm	Contents PU pcs	Weight kg/PU	Shipping box PU	Item No.
KLS 27	Natural	2.0 - 3.3	700	0.45	10	954 90 0
KLS 34	Natural	2.0 - 3.3	400	0.58	10	954 90 6



KLS nail disc with nail (KG006)

Plastic disc with pre-mounted nail.
With the KLS nail disc, you can fasten multiple cables in a single step.
Practical in masonry slots and under insulation material.

Polypropylene

Type	Colour	Diameter mm	Shank Ø mm	Nail length mm	Contents PU pcs	Weight kg/PU	Shipping box PU	Item No.
KLS 27x2,0x40	Natural	27.00	2.00	40.00	300	0.54	10	954 90 2
KLS 27x2,0x50	Natural	27.00	2.00	50.00	250	0.52	10	954 90 4
KLS 34x2,0x50	Natural	34.00	2.00	50.00	150	0.33	10	954 90 8
KLS 34x2,0x60	Natural	34.00	2.00	60.00	150	0.50	10	954 91 0
KLS 34x3,3x40	Natural	34.00	3.30	40.00	150	0.70	10	954 91 2
KLS 34x3,3x50	Natural	34.00	3.30	50.00	150	0.80	10	954 91 4
KLS 34x3,3x60	Natural	34.00	3.30	60.00	100	0.60	10	954 91 6

CHARACTERISTIC:

- Rapid cable fastening in masonry slots or on masonry before plastering
- With hardened, galvanised steel nail
- The cables sit tightly on the masonry
- The oval shape is perfect for flexible cable routing

OKS nail disc without nail (KG008)

Plastic disc without pre-mounted nail.
With the OKS nail disc, you can fasten multiple cables in a single step.
Practical in masonry slots and under insulation material.

Polypropylene

Type	Colour	External dimensions mm	For nail Ø x l mm	Contents PU pcs	Weight kg/PU	Shipping box PU	Item No.
OKS 25-40	Natural	25x40	3	150	0.18	10	954 93 0



OKS nail disc with nail (KG008)

Plastic disc with pre-mounted nail.
With the OKS nail disc, you can fasten multiple cables in a single step.
Practical in masonry slots and under insulation material.

Polypropylene

Type	Colour	External dimensions mm	Shank Ø mm	Nail length mm	Contents PU pcs	Weight kg/PU	Shipping box PU	Item No.
OKS 25-40x3,0x40	Natural	25x40	3.00	40.00	150	0.45	10	954 93 4
OKS 25-40x3,0x40	Natural	25x40	3.00	50.00	150	0.57	10	954 93 8
OKS 25-40x3,0x60	Natural	25x40	3.00	60.00	150	0.64	10	954 94 2
OKS 25-40x3,0x70	Natural	25x40	3.00	70.00	150	0.73	10	954 94 6



Nail disc DKS

CHARACTERISTIC:

- Rapid cable fastening in masonry slots or on masonry before plastering
- With hardened, galvanised steel nail
- The cables sit tightly on the masonry
- Optimised for use in masonry slots
- Flexible disc allows careful cable mounting



DKS nail disc with nail (KG014)

Plastic disc with pre-mounted nail.
With the DKS nail disc, you can fasten multiple cables in a single step.
Practical in masonry slots and under insulation material.

Polypropylene

Type	Colour	External dimensions mm	Shank Ø mm	Nail length mm	Contents PU pcs	Weight kg/PU	Shipping box PU	Item No.
DKS 25-34x3,0x40	Natural	25x34	3.00	40.00	100	0.27	12	954 92 6
DKS 25-34x3,50x50	Natural	25x34	3.50	50.00	100	0.38	12	954 92 7
DKS 25-34x3,50x60	Natural	25x34	3.50	60.00	100	0.46	12	954 92 8
DKS 25-34x3,50x70	Natural	25x34	3.50	70.00	100	0.55	12	954 92 9

Speedclip SCP

Save time and money with high speed



Seven good reasons for the Speedclip SCP:

1. Up to 50% time savings

- Through quick and easy impact mounting

2. Available with and without pre-mounted anchor

- Also available with 5 mm Speedplug nail anchor

3. Nylon clip and anchor

- Tear-resistant, heat and cold-resistant
- Resistant to aging

4. Galvanised nail with impact-protected Philips head

- For a high level of rust resistance and easy dismantling

5. Also available with "DUO-block"

- Fasten two pipes with a single seat – could it be more effective?

6. Simple installation

- Without obstacles

7. KIWA-certified

Clamp clip, plastic, SCP

CHARACTERISTIC:

- Up to 50% time savings
- Easy, quick mounting
- 3:1 combination (3 applications unified in a product)
- Mounting correction through slot
- Also available as "DUO-Block"
- Some products KIWA-certified for the Dutch market
- Also available with 5 mm nail anchor (ESCP)
- Multiple pipe dimensions combined for each clip

TECHNICAL DATA:

- *Plastic:*
 - Halogen and silicone-free
 - Colour: Grey (RAL7035)
 - Temperature resistance:
 - 80 °C, long term
 - 130 °C, short term
 - - 10 °C mounting
 - - 40 °C use
 - Flame-resistance: UL 94 HB
 - UV-resistant: The product can be used under UV-radiation (weathering) in both dry and warm climates and also in humid, warm climates for at least 5 to 6 years, without any change in the use properties
- *Nail:*
 - Steel, galvanised (blue annealed)



Clamp clip, plastic without nail anchor SCP-M6 (CP000)

Clip for simple, exact, rapid and safe fastening of copper pipes, steel armoured pipes DIN 49 020 and heavy-duty insulating pipes DIN 49 016 using impact mounting without any other aids.

Polyamide

Type	Colour	For pipe Ø mm	Contents PU pcs	Weight kg/PU	Shipping box PU	Item No.
SPC 10,12xM6	Grey	10; 12	100	1.01	10	963 40 7
SPC 15,16xM6	Grey	15; 16	100	0.90	10	963 41 5
SPC 18,19xM6	Grey	18; 19	100	1.18	10	963 42 3
SPC 20,22xM6	Grey	20; 22	100	1.05	10	963 43 1
SPC 25,28xM6	Grey	25; 28	50	0.73	10	963 45 8



Clamp clip, plastic with nail anchor ø5 mm SCP (CP000)

Clip for simple, exact, rapid and safe fastening of copper pipes, steel armoured pipes DIN 49 020 and heavy-duty insulating pipes DIN 49 016 using impact mounting without any other aids.

Polyamide

Type	Colour	Dowel Ø mm	Anchor length mm	For pipe Ø mm	Contents PU pcs	Weight kg/PU	Shipping box PU	Item No.
ESCP 15,16x5x28	Grey	5.00	28.00	15; 16	100	0.74	5	963 11 6
ESCP 18,19x5x28	Grey	5.00	28.00	18; 19	100	0.94	5	963 12 4

Clamp clip, plastic with nail anchor $\varnothing 6$ mm SCP (CP000)

Clip for simple, exact, rapid and safe fastening of copper pipes, steel armoured pipes DIN 49 020 and heavy-duty insulating pipes DIN 49 016 using impact mounting without any other aids.

Polyamide

Type	Colour	Dowel \varnothing mm	Anchor length mm	For pipe \varnothing mm	Contents PU pcs	Weight kg/PU	Shipping box PU	Item No.
SCP 10,12x6x40	Grey	6.00	40.00	10; 12	100	1.01	5	963 05 2
SCP 15,16x6x40	Grey	6.00	40.00	15; 16	100	1.12	5	963 06 0
SCP 18,19x6x40	Grey	6.00	40.00	18; 19	100	1.22	5	963 07 9
SCP 20,22x6x40	Grey	6.00	40.00	20; 22	100	1.28	5	963 08 7
SCP 25,28x6x40	Grey	6.00	40.00	25; 28	100	1.50	5	963 16 7
SCP 35x6x50	Grey	6.00	50.00	35	50	1.25	5	966 16 5
SCP 42x6x50	Grey	6.00	50.00	42	50	1.47	5	966 17 2
SCP 54x6x50	Grey	6.00	50.00	54	25	0.73	5	966 18 4
SCP 63x6x50	Grey	6.00	50.00	63	25	0.86	5	966 19 3



Clamp clip, plastic, SCP DUO



Clamp clip, plastic without nail anchor SCP-M6 DUO (CP000)

Clip for simple, exact, rapid and safe fastening of copper pipes, steel armoured pipes DIN 49 020 and heavy-duty insulating pipes DIN 49 016 using impact mounting without any other aids.

Polyamide

Type	Colour	For pipe Ø mm	Contents PU pcs	Weight kg/PU	Shipping box PU	Item No.
SPC 10,12xM6	Grey	10; 12	25	0.59	10	963 50 3
SPC 15,16xM6	Grey	15; 16	25	0.52	10	963 51 1
SPC 20,22xM6	Grey	20; 22	25	0.62	10	963 54 6



Clamp clip, plastic with nail anchor SCP DUO (CP000)

Clip for simple, exact, rapid and safe fastening of copper pipes, steel armoured pipes DIN 49 020 and heavy-duty insulating pipes DIN 49 016 using impact mounting without any other aids.

Polyamide

Type	Colour	Dowel Ø mm	Anchor length mm	For pipe Ø mm	Contents PU pcs	Weight kg/PU	Shipping box PU	Item No.
SPC 10,12x6x55	Grey	6.00	55.00	10;12	50	1.14	5	963 30 0
SPC 15,16x6x55	Grey	6.00	55.00	15; 16	50	1.21	5	963 31 9
SPC 18,19x6x55	Grey	6.00	55.00	18; 19	50	1.43	5	963 32 7
SPC 20,22x6x55	Grey	6.00	55.00	20; 22	50	1.48	5	963 33 5

CHARACTERISTIC:

- Time and cost savings during mounting
- 3:1 combination (3 applications unified in a product)
- Corrosion-resistant
- No screwdriver required for mounting, simply knock-in
- Simple dismantling using screwdriver for renovation and maintenance work
- Available in grey (RAL 7037) and white (RAL 9010)

TECHNICAL DATA:

- *Plastic:*
 - Clip: PVC
 - Block: Polypropylene
- *Speedplug:*
 - Nail: Steel, galvanised
 - Anchor: Polyamide PA-6

Pipe clamp KPA white (OZ006)

To fasten PVC rain pipes.
Polyvinylchloride

Type	Colour	Dimension	For pipe Ø mm	Contents PU pcs	Weight kg/PU	Shipping box PU	Item No.
KPA 80x8x70	White	80 x 8 x 70	80	25	1.18	4	932 00 7
KPA 100x8x70	White	100 x 8 x 70	100	25	1.29	4	932 00 8



Pipe clamp KPA grey (OZ006)

To fasten PVC rain pipes.
Polyvinylchloride

Type	Colour	Smallest sales unit	For pipe Ø mm	Contents PU pcs	Weight kg/PU	Shipping box PU	Item No.
KPA 70x8x70	Grey	1.00	70	25	1.13	4	932 00 0
KPA 80x8x70	Grey	1.00	80	25	1.18	4	932 00 1
KPA 100x8x70	Grey	1.00	100	25	1.29	4	932 00 2



Nail anchor SPS 8*100 (OZ011)

Nail anchor for fastening the KPA pipe clamp onto the support.
Polyamide

Type	Colour	Dowel Ø mm	Anchor length mm	For pipe Ø mm	Contents PU pcs	Weight kg/PU	Shipping box PU	Item No.
KPA 8x100	Grey	8.00	100.00	—	50	0.58	1	932 02 8



Pipe clip, plastic, KPA



Spacer for pipe clamp KPA white (OZ011)

Spacer for addition space between the wall and pipe.
Polypropylene

Type	Colour	Dimension	For pipe Ø mm	Contents PU pcs	Weight kg/PU	Shipping box PU	Item No.
KPA B w	White	x	—	50	0.35	1	932 02 6



Spacer for pipe clamp KPA grey (OZ011)

Spacer for addition space between the wall and pipe.
Polypropylene

Type	Colour	Dimension	For pipe Ø mm	Contents PU pcs	Weight kg/PU	Shipping box PU	Item No.
KPA B g	Grey	x	—	50	0.35	1	932 02 4



Joint expansion set for pipe clip KPA (M005)

Contents:
V2A plate 30 x 102
V2A bolt with slot drive
M8 thread 8 x 20 mm
Speedplug nail anchor SPTB 6x50
Stainless steel, grade 304

Type	Colour	Dimension	For pipe Ø mm	Contents PU pcs	Weight kg/PU	Shipping box PU	Item No.
KPA 30x102	Grey	102 x 30	—	25	1.35	1	932 03 0

CHARACTERISTIC:

- Pre-mounted stainless steel M8 sliding nut
- Can be mounted directly, without prior deburring, on a damaged thread end (M6 and M8)
- One clip for multiple pipe dimensions
- Flexible location of the lock
- Can be mounted quickly and easily with the tensioner supplied
- Considerable time savings during mounting

TECHNICAL DATA:

- *Plastic:*
- Polyamide PA-6
- Halogen and silicone-free
- Colour: Grey (RAL7037)
- Temperature resistance:
 - 80 °C, long term
 - 130 °C, short term
 - -10 °C mounting
 - -40 °C use
- Flame-resistance: UL 94 V2 - 1.6 mm
- UV-resistant: The product can be used under UV-radiation (weathering) in both dry and warm climates and also in humid, warm climates for at least 5 to 6 years, without any change in the use properties

INSTRUCTIONS FOR USE:

M6 bushing

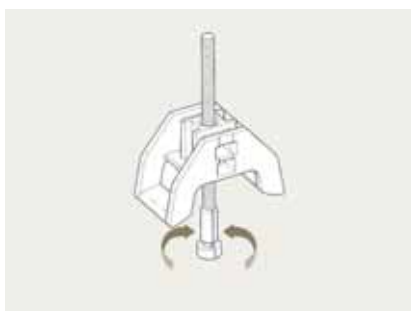

Turn the M6 bushing onto the M6 thread end

INSTRUCTIONS FOR USE:

Nail anchor SP 8x70



Knock the nail anchor SP 8x70 into the drill hole

INSTRUCTIONS FOR USE:

Tensioner



UNO tensions for secure tensioning of the strip

INSTRUCTIONS FOR USE:

M8 thread end with stainless steel slide nut.

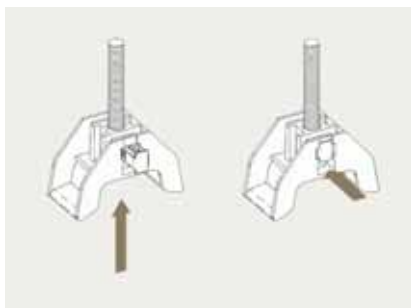

Insert the M8 thread and fix it with a slide nut

Pipe clip, plastic, UNO

Pipe clamp UNO-LB (OZ035)



Fastening system consisting of a block and a strip for fastening PV pipes of Ø 40 mm to Ø 125 mm and ventilation pipe types of up to Ø 350 mm (with extension strip), only for suspended mounting. Available with and without rubber noise damper. Maximum load 30 kg.

Polyamide

Type	Colour	Dimension	Contents PU pcs	Weight kg/PU	Shipping box PU	Item No.
UNO 40-125xM8	Dusty grey	40-125xM8	25	1.30	5	963 26 2

Pipe clamp UNO-LBD with rubber noise dampener (OZ034)



Fastening system consisting of a block and a strip for fastening PV pipes of Ø 40 mm to Ø 125 mm and ventilation pipe types of up to Ø 350 mm (with extension strip), only for suspended mounting. Available with and without rubber noise damper. Maximum load 30 kg.

Polyamide

Type	Colour	Dimension	Contents PU pcs	Weight kg/PU	Shipping box PU	Item No.
UNO 40-125xM8	Dusty grey	40-125xM8	25	1.65	5	963 26 4

M6 bushing for pipe clip UNO-LB/-LBD (M007)



Fastening system consisting of a block and a strip for fastening PV pipes of Ø 40 mm to Ø 125 mm and ventilation pipe types of up to Ø 350 mm (with extension strip), only for suspended mounting. Available with and without rubber noise damper. Maximum load 30 kg.

Polyamide

Type	Colour	Dimension	Contents PU pcs	Weight kg/PU	Shipping box PU	Item No.
M007S M6	Dusty grey	M6	100	0.15	5	933 02 0

Strip for pipe clamp UNO-LB/-LBD (OZ023)



Extension strip for ventilation pipe types up to Ø 350 mm for suspended mounting.

Polyamide

Type	Colour	Dimension	Contents PU pcs	Weight kg/PU	Shipping box PU	Item No.
UNO B	Dusty grey	20 x 525	50	1.30	5	963 25 5

Nail anchor SP 8/70 MZ for pipe clamp UNO-LB/-LBD (OZ023)

Nail anchor SP 8 x 70 for drill hole mounting

Polyamide

Type	Colour	Dimension	Contents PU pcs	Weight kg/PU	Shipping box PU	Item No.
SPM 8x70	Natural	8 x 70	50	0.59	5	961 00 0



Tensioner for pipe clamp UNO-LB/-LBD (HG001)

Can be mounted quickly and easily with the tensioner.

Polyamide

Type	Colour	Dimension	Contents PU pcs	Weight kg/PU	Shipping box PU	Item No.
UNO 30x110x19	Red	30 x 110 x 19	1	0.02	1	901 18 3



ISO pressure clip

CHARACTERISTIC:

- Clip made of impact-resistant polystyrene
- With adhesive foot, slot or for screwing to M6 thread
- Clamping range 6–16 mm
- Colour: Light grey RAL7035



ISO pressure clip for 1 cable (OZ060)

To fasten cables and pipes.

Polystyrene

Type	Colour	For cable Ø mm	Contents PU pcs	Weight kg/PU	Shipping box PU	Item No.
OZ060 6x16	Grey	6.00-16.00	100	0.46	8	904 45 5



ISO pressure clip for 2 cables (OZ061)

To fasten cables and pipes.

Polystyrene

Type	Colour	For cable Ø mm	Contents PU pcs	Weight kg/PU	Shipping box PU	Item No.
OZ061 6x16	Grey	6.00-16.00	25	0.26	10	904 45 6



Nail anchor SPM M6 (PL029)

Nail anchor for electrical engineers and sanitary installation engineers for clip fastening using an M6 thread.

Polyamide

Type	Colour	Dowel Ø mm	Anchor length mm	Thread size M	Thread increase mm	Contents PU pcs	Weight kg/PU	Shipping box PU	Item No.
SPM 6x40	Natural	6.00	40.00	6.00	1.00	200	1.33	10	960 00 3
SPM 6x80	Natural	6.00	80.00	6.00	1.00	100	0.96	10	943 11 5

CHARACTERISTIC:

- Clip made of impact-resistant polystyrene
- With adhesive foot, slot or for screwing to M6 thread
- Clamping range 6–16 mm
- The cable is fixed using the clamping screw
- Colour: Light grey RAL7035

ISO grip clip for 1 cable (OZ062)

To fasten cables and pipes.

Polystyrene

Type	Colour	For cable Ø mm	Contents PU pcs	Weight kg/PU	Shipping box PU	Item No.
OZ062 6x16	Grey	6.00-16.00	100	0.74	12	904 45 7



ISO grip clip for 2 cables (OZ063)

To fasten cables and pipes.

Polystyrene

Type	Colour	For cable Ø mm	Contents PU pcs	Weight kg/PU	Shipping box PU	Item No.
OZ063 6x16	Grey	6.00-16.00	25	0.30	10	904 45 8



Nail anchor SPM M6 (PL029)

Nail anchor for electrical engineers and sanitary installation engineers for clip fastening using an M6 thread.

Polyamide

Type	Colour	Dowel Ø mm	Anchor length mm	Thread size M	Thread increase mm	Contents PU pcs	Weight kg/PU	Shipping box PU	Item No.
SPM 6x40	Natural	6.00	40.00	6.00	1.00	200	1.33	10	960 00 3
SPM 6x80	Natural	6.00	80.00	6.00	1.00	100	0.96	10	943 11 5



Pipe clamp SCO

Pre-mounted in your hand and quickly in the wall



Seven good reasons for the quick clip from Helmond:

- 1. Up to 50% time savings**
 - Through quick and easy impact mounting
- 2. Single-handed mounting**
 - Ensures the greatest possible safety
- 3. Nylon clip and pre-mounted anchor**
 - Tear-resistant, heat and cold-resistant
 - Resistant to aging
- 4. Galvanised nail with impact-protected Philips head**
 - For a high level of rust resistance and easy dismantling
- 5. Multiple pipe dimensions combined for each clip**
- 6. Simple installation**
 - Without obstacles
- 7. Expandable**
 - With practically any pipe clamps

CHARACTERISTIC:

- Pre-mounted nail anchor can be knocked in simply with a hammer
- More safety and time savings through "single-handed" mounting
- Clip for multiple pipe dimensions
- Mounting correction through slot
- Arrangeable with pipe clip OPDZ

Fastening clip SCO (OZ004)

For rational and rapid fastening of steel armoured pipes DIN 49 020 and heavy-duty insulating pipes DIN 49 016 using impact mounting without any other aids.

Polyamide

Type	Colour	Dowel Ø	Anchor length	For pipe Ø	Thread size PG	Contents PU	Weight	Shipping box	Item No.
		mm	mm	mm		pcs	kg/PU	PU	
SCO 9x5x30	Grey	5.00	30.00	16 - 19	9.00	150	1.27	4	991 20 4
SCO 9x6x35	Grey	6.00	35.00	16 - 19	9.00	150	1.47	4	991 20 5
SCO 13,5-16x6x35	Grey	6.00	35.00	28	13.50	150	1.71	4	991 21 3
SCO 21x6x35	Grey	6.00	35.00	20 - 23	21.00	150	2.10	4	991 20 7



Fastening clip, plastic OPDZ

CHARACTERISTIC:

- Universal fastening options
- Mounting correction with slot during mounting with 5 or 6 mm knock-in anchors or wood screw
- Can be slotted into C profile rails with slot width 11 mm
- Arrangeable with practically any pipe clamps
- 5/8" (16 mm) and 3/4" (19 mm) KEMA-certified

INSTRUCTIONS FOR USE:

6 mm hole: Impact mounting, 6 mm nail anchor, screw mounting (head ø 8 mm)

5 mm hole: Impact mounting, 5 mm nail anchor, screw mounting or mounting on M6 thread

COMPARE DIMENSIONS IN METRIC-PG-INCHES-IRO

Pipe diameter [mm]	Metric	PG	Inch	IRO
12-13	12	7		11
15-16	16	9	5/8	13.5
18-19		11	3/4	16
20-21	20	13.5		19
22-23		16		
25-26	25		1	23
28-29		21		23
31-32	32		1 1/4	29
37-38		29	1 1/2	
38-40	40			36
47-48		36		
50	50			
53-54		42		
59-60		48		
63	63			



Pipe clamp, OPDZ 6 mm grey (OZ029)

For simple and exact fastening of steel armoured pipes DIN 49 020 and heavy-duty insulating pipes DIN 49 016.

Polypropylene

Type	Colour	For pipe Ø mm	Thread size M	Thread size PG	For pipe Ø inch	Contents PU pcs	Weight kg/PU	Shipping box PU	Item No.
OPDZ 15-16x5/8	Grey	15-16	16.00	9.00	5/8	100	0.35	10	981 90 2
OPDZ 18-19x3/4	Grey	18-19	—	11.00	3/4	100	0.56	10	981 91 0
OPDZ 20-21	Grey	20-21	20.00	13.50	—	100	0.34	10	981 92 4
OPDZ 22-23	Grey	22-23	—	16.00	—	100	0.70	10	981 93 7
OPDZ 25-26x1	Grey	25-26	25.00	—	1	50	0.30	10	981 95 0
OPDZ 28-29	Grey	26-29	—	21.00	—	50	0.49	10	981 94 4
OPDZ 31-32x1 1/4	Grey	31-32	32.00	—	1 1/4	50	0.40	10	981 95 8
OPDZ 37-38x1 1/2	Grey	37-38	—	29.00	1 1/2	50	0.73	10	981 95 5
OPDZ 38-40	Grey	38-40	40.00	—	—	30	0.35	10	981 96 0
OPDZ 47-48	Grey	47-48	—	36.00	—	30	0.71	10	994 61 1
OPDZ 50	Grey	50	50.00	—	—	30	0.58	10	994 62 8
OPDZ 53-54	Grey	53-54	—	42.00	—	25	0.64	10	994 60 0
OPDZ 59-60	Grey	59-60	—	48.00	—	20	0.64	10	994 60 2
OPDZ 63	Grey	63	63.00	—	—	20	0.40	10	994 62 9

Pipe clamp, OPDZ 6 mm grey (OZ029)

For simple and exact fastening of steel armoured pipes DIN 49 020 and heavy-duty insulating pipes DIN 49 016.

Polyamide

Type	Colour	For pipe Ø	Thread size M	Thread size PG	For pipe Ø	Contents PU	Weight	Shipping box	Item No.
		mm			inch	pcs	kg/PU	PU	
OPDZ 15-16x5/8	Grey	15-16	16.00	9.00	5/8	100	0.40	10	982 00 5
OPDZ 18-19x3/4	Grey	18-19	—	11.00	3/4	100	0.45	10	982 00 7



Pipe clamp, OPDZ 6 mm cream KEMA (OZ043)

For simple and exact fastening of steel armoured pipes DIN 49 020 and heavy-duty insulating pipes DIN 49 016.

Polyamide

Type	Colour	For pipe Ø	Thread size M	Thread size PG	For pipe Ø	Contents PU	Weight	Shipping box	Item No.
		mm			inch	pcs	kg/PU	PU	
OPDZ 15-16x5/8	Cream	15-16	16.00	9.00	5/8	100	0.47	10	981 91 7
OPDZ 18-19x3/4	Cream	18-19	—	11.00	3/4	100	0.56	10	981 91 8



Pipe clamp, OPDZ 5 mm dark grey KEMA (OZ043)

For rational and exact fastening of steel armoured pipes DIN 49 020 and heavy-duty insulating pipes DIN 49 016.

Suitable for mounting with M6 anchors.

Polyamide

Type	Colour	For pipe Ø	Thread size M	Thread size PG	For pipe Ø	Contents PU	Weight	Shipping box	Item No.
		mm			inch	pcs	kg/PU	PU	
OPDZ 15-16x5/8	Dusty grey	15-16	16.00	9.00	5/8	100	0.40	10	981 88 6
OPDZ 18-19x3/4	Dusty grey	18-19	—	11.00	3/4	100	0.56	10	981 91 4



Pipe clamp, OPDZ 5 mm grey (OZ045)

For rational and exact fastening of steel armoured pipes DIN 49 020 and heavy-duty insulating pipes DIN 49 016.

Suitable for mounting with M6 anchors.

Polypropylene

Type	Colour	For pipe Ø	Thread size M	Thread size PG	For pipe Ø	Contents PU	Weight	Shipping box	Item No.
		mm			inch	pcs	kg/PU	PU	
OPDZ 12-13	Grey	12-13	12.00	7.00	—	100	0.36	10	981 90 0
OPDZ 15-16x5/8	Grey	15-16	16.00	9.00	5/8	100	0.47	10	981 86 0
OPDZ 18-19x3/4	Grey	18-19	—	11.00	3/4	100	0.56	10	981 86 1
OPDZ 20-21	Grey	20-21	20.00	13.50	—	100	0.47	10	981 86 2
OPDZ 22-23	Grey	22-23	—	16.00	—	100	0.70	10	981 86 3
OPDZ 25-26x1	Grey	25-26	25.00	—	1	50	0.30	10	981 86 6
OPDZ 28-29	Grey	28-29	—	21.00	—	50	0.49	10	981 86 4
OPDZ 37-38	Grey	37-38	—	29.00	1 1/2	50	0.73	10	981 86 5



Fastening clip, plastic OPDZ



M6 anchor (KS266,KS274,KS282)

To fasten clips on concrete without anchors.

Steel, Hardened Electrogalvanised

Type	Shank Ø		Nail length mm	Contents PU pcs	Weight kg/PU	Shipping box PU	Item No.
	mm	mm					
KS274 8x15	8.00	15.00		100	0.31	70	957 10 6
KS282 8x18	8.00	18.00		100	0.37	70	957 09 4
KS282 8x25	8.00	25.00		100	0.43	70	957 11 0
KS282 8x30	8.00	30.00		100	0.49	70	957 11 2
KS282 8x40	8.00	40.00		100	0.59	70	957 11 6
KS266 8x55	8.00	55.00		100	0.69	70	957 11 8
KS266 8x70	8.00	70.00		100	0.84	40	957 12 0



Nail anchor SPM M6 (PL029)

Nail anchor for electrical engineers and sanitary installation engineers for clip fastening using an M6 thread.

Polyamide

Type	Colour	Dowel Ø mm	Anchor length mm	Thread size M	Thread increase mm	Contents PU pcs	Weight kg/PU	Shipping box PU	Item No.
SPM 6x80	Natural	6.00	80.00	6.00	1.00	100	0.96	10	943 11 5

CHARACTERISTIC:

- Quick, easy installation
- Fastening without screwing or knocking-in, simple push-through mounting
- Mounting correction through slot
- Arrangeable pipe clip OPDZ

INSTRUCTIONS FOR USE:

- Drill hole: \varnothing 6 mm
- Depth: 40 mm
- Push the push-fit anchor into the drill hole by hand – and you're done
- Alignment through slot possible

Fastening clip OPDZ STP (OZ040)

Mount the pipe clamp with push-fit anchor by hand without tools.

Polypropylene

Type	Colour	For pipe Ø mm	Thread size M	Thread size PG	For pipe Ø inch	Contents PU pcs	Weight kg/PU	Shipping box PU	Item No.
STB 15-16x5/8	Grey	15-16	16.00	9.00	5/8	100	0.55	10	981 99 7
STB 18-19x3/4	Grey	18-19	–	11.00	3/4	100	0.63	10	981 99 8
STB 20-21	Grey	20-21	20.00	13.50	–	100	0.59	10	981 99 9
STB 22-23	Grey	22-23	–	16.00	–	100	0.58	10	982 00 0
STB 25	Grey	25	25.00	–	1	50	0.64	10	982 00 2
STB 28-29	Grey	28-29	–	21.00	–	50	0.63	10	982 00 1
STB 31-32	Grey	31-32	32.00	–	1 ¼	50	0.77	10	982 01 3



Fastening clip, plastic, OPDZ TF (Total-Fixx)

CHARACTERISTIC:

- Universal fastening options thanks to the Total-Fixx anchor
- Total-Fixx fastening element, incl. nail, is already pre-mounted
- Mounting correction through slot
- Arrangeable pipe clip OPDZ



Fastening clip OPDZ TF (OZ055)

To fasten electrical installation pipes with pre-mounted Total-Fixx. Can be used universally in solid substrates and cavities.

Polypropylene

Type	Colour	For pipe Ø mm	Thread size M	Thread size PG	For pipe Ø inch	Contents PU pcs	Weight kg/PU	Shipping box PU	Item No.
OPDZ-TF 15-16x5/8	Grey	15-16	16.00	9.00	5/8	100	0.88	10	981 98 5
OPDZ-TF 18-19x3/4	Grey	18-19	—	11.00	3/4	100	1.01	10	981 98 6
OPDZ-TF 20-21	Grey	20-21	20.00	13.50	—	100	1.04	10	981 98 7
OPDZ-TF 22-23	Grey	22-23	—	16.00	—	100	1.12	10	981 98 8
OPDZ-TF 25-26x1	Grey	25-26	25.00	—	1	100	1.34	10	981 94 9
OPDZ-TF 28-29	Grey	28-29	—	21.00	—	50	0.71	10	981 98 9

CHARACTERISTIC:

- Steel, galvanised (blue annealed)
- Suitable for use with Fixpin

Fastening clip, single, 1-hole, \varnothing 5.5 mm, width 15 mm (MZ020)

To fasten pipes and cables on concrete.

Steel Electrogalvanised

Type	Thread size M	Thread size PG	For pipe \varnothing inch	For pipe \varnothing mm	Contents PU pcs	Weight kg/PU	Shipping box PU	Item No.
MZ020 M16x15-16	16.00	9.00	5/8	15-16	250	2.00	4	900 90 0
MZ020 E18x17-18	–	11.00	3/4	17-18	200	2.60	4	900 90 1
MZ020 M20x19-20	20.00	13.50	–	19-20	200	1.88	4	900 90 2
MZ020 E22x21-22	–	–	–	21-22	175	1.88	4	900 90 3
MZ020 E24x23-24	–	16.00	–	23-24	150	1.75	4	900 91 8
MZ020 M25x24-25	25.00	–	1	24-25	150	1.75	4	900 90 9



Fastening clip, single, 1-hole, \varnothing 5.5 mm, width 20 mm (MZ020)

To fasten pipes and cables on concrete.

Steel Electrogalvanised

Type	Thread size M	Thread size PG	For pipe \varnothing inch	For pipe \varnothing mm	Contents PU pcs	Weight kg/PU	Shipping box PU	Item No.
MZ020 E28x27-28	–	21.00	–	27-28	125	2.23	30	900 90 4
MZ020 M32x31-32	32.00	–	1 1/4	31-32	100	2.20	2	900 89 9
MZ020 E35x34-35	–	–	–	34-35	100	2.20	2	900 91 9
MZ020 M40x39-40	40.00	–	–	39-40	100	2.30	2	900 92 0



Fastening clip, single, 1-hole, \varnothing 6.5 mm, (MZ031)

To fasten pipes and cables on concrete.

Steel Electrogalvanised

Type	For pipe \varnothing mm	Contents PU pcs	Weight kg/PU	Shipping box PU	Item No.
MZ031 E5x5	5	100	0.33	30	901 00 0
MZ031 E6x6	6	100	0.39	24	901 00 1
MZ031 E7x7	7	100	0.42	20	901 00 2
MZ031 E8x8	8	100	0.43	20	901 00 3
MZ031 E9x9	9	100	0.47	20	901 00 4
MZ031 E10x10	10	100	0.56	20	901 00 5
MZ031 E11x11	11	100	0.63	18	901 00 6
MZ031 E12x12	12	100	0.67	10	901 00 7
MZ031 E13x13	13	100	0.68	18	901 00 8
MZ031 E14x14	14	100	0.71	12	901 00 9
MZ031 E15x15	15	100	0.74	12	901 01 0
MZ031 E16x16	16	100	0.75	12	901 01 1
MZ031 E17x17	17	100	0.76	12	901 01 2
MZ031 E18x18	18	100	0.84	12	901 01 3



Fastening clip, single, metal



Fastening clip, single, 2-hole, \varnothing 6.5 mm (MZ032)

To fasten pipes and cables on concrete.

Steel Electrogalvanised

Type	For pipe \varnothing mm	Contents PU pcs	Weight kg/PU	Shipping box PU	Item No.
MZ032 M12	12	100	0.49	20	901 04 0
MZ032 M16	16	100	0.59	12	901 04 1
MZ032 M20	20	100	0.66	10	901 04 2
MZ032 M25	25	100	0.96	12	901 04 3
MZ032 E28	28	25	10.67	12	901 04 8
MZ032 M32	32	100	1.26	12	901 04 4
MZ032 M40	40	50	1.90	6	901 04 5
MZ032 M50	50	25	2.77	3	901 04 6
MZ032 M63	63	25	3.67	3	901 04 7

Fastening clip, double, 1-hole, \varnothing 5.5 mm, (MZ019)

To fasten pipes and cables on concrete.

Steel Electrogalvanised

Type	Thread size M	Thread size PG	For pipe \varnothing inch	For pipe \varnothing mm	Contents PU pcs	Weight kg/PU	Shipping box PU	Item No.
MZ019 M16x15-16	16.00	9.00	5/8	15-16	150	2.77	4	900 90 5
MZ019 E18x17-18	–	11.00	3/4	17-18	100	2.67	4	900 92 1
MZ019 M20x19-20	20.00	13.50	–	19-20	100	2.25	2	900 91 0
MZ019 E22x21-22	–	–	–	21-22	100	2.41	2	900 90 7
MZ019 E24x23-24	–	16.00	–	23-24	100	2.50	2	900 92 2
MZ019 M25x24-25	25.00	–	1	24-25	100	2.80	2	900 91 3
MZ019 E28x27-28	–	21.00	–	27-28	50	1.50	2	900 91 1
MZ019 E35x34-35	–	–	–	34-35	25	1.00	4	900 92 3
MZ019 E40x39-40	40.00	–	–	39-40	25	1.05	4	900 92 4



Spacer clip, straight slot, metal

CHARACTERISTIC:

- Quick pipe and cable routing without the need to dismantle the complete clip, thanks to swivelling hips



Spacer clip straight slot (MZ033)

To fasten cables, empty pipes and pipes at a distance to the substrate.

Steel Electrogalvanised

Type	Thread size M	For pipe Ø mm	Contents PU pcs	Weight kg/PU	Shipping box PU	Item No.
MZ033 M12	12.00	11.00-13.00	50	1.16	12	904 30 0
MZ033 M16	16.00	14.00-16.00	50	1.22	10	904 30 1
MZ033 M20	20.00	19.00-21.00	50	1.25	10	904 30 2
MZ033 M25	25.00	24.00-29.00	50	1.37	9	904 30 3
MZ033 M32	32.00	30.00-38.00	25	1.01	10	904 30 4
MZ033 M40	40.00	39.00-48.00	25	1.20	12	904 30 5
MZ033 M50	50.00	48.00-54.00	25	1.45	12	904 30 6
MZ033 M63	63.00	63.00	20	1.74	8	904 30 7

Spacer clip, M6 thread, metal M6

CHARACTERISTIC:

- Quick pipe and cable routing without the need to dismantle the complete clip, thanks to upper clip

Spacer clip thread M6 (MZ034)

To fasten cables, empty pipes and pipes at a distance to the substrate.

Steel Electrogalvanised

Type	Thread size M	For pipe Ø mm	Contents PU pcs	Weight kg/PU	Shipping box PU	Item No.
MZ034 5-6	6.00	5.00-6.00	100	1.16	12	904 30 8
MZ034 7-8	6.00	7.00-8.00	100	1.31	12	904 30 9
MZ034 9-10	6.00	9.00-10.00	100	1.36	10	904 31 0
MZ034 10,5-12	12.00	10.50-12.00	100	1.46	10	904 31 1
MZ034 12,5-14	6.00	12.50-14.00	100	1.48	10	904 31 2
MZ034 13,5-15	6.00	13.50-15.00	100	1.53	10	904 31 3
MZ034 14,5-16	16.00	14.50-16.00	100	1.59	10	904 31 4
MZ034 16,5-18	6.00	16.50-18.00	100	1.62	10	904 31 5
MZ034 18,5-20	20.00	18.50-20.00	50	0.87	12	904 31 6
MZ034 20-22	6.00	20.00-22.00	50	0.89	10	904 31 7
MZ034 22-24	6.00	22.00-24.00	50	0.92	10	904 31 8
MZ034 24-26	25.00	24.00-26.00	50	0.96	10	904 31 9
MZ034 26-28	6.00	26.00-28.00	50	1.42	10	904 32 0
MZ034 28-30	6.00	28.00-30.00	50	1.52	8	904 32 1
MZ034 31-33	32.00	31.00-33.00	25	0.78	10	904 32 2
MZ034 33-35	6.00	33.00-35.00	25	0.82	10	904 32 3
MZ034 36-38	6.00	36.00-38.00	25	0.87	10	904 32 4
MZ034 38-40	40.00	38.00-40.00	25	0.90	10	904 32 5
MZ034 40-42	40.00	40.00-42.00	25	0.96	10	904 32 6
MZ034 43-45	6.00	43.00-45.00	25	1.00	10	904 32 7
MZ034 46-48	6.00	46.00-48.00	25	1.00	10	904 32 8
MZ034 48-50	50.00	48.00-50.00	25	1.04	8	904 32 9
MZ034 58-60	6.00	58.00-60.00	25	1.24	8	904 33 0
MZ034 61-63	63.00	61.00-63.00	25	1.25	8	904 33 1



Speedplug SPM, countersunk collar, countersunk head

Nail anchor for electrical engineers and sanitary installation engineers for clip fastening using an M6 thread.

Polyamide

Type	Colour	Dowel Ø mm	Anchor length mm	Thread size M	Thread increase mm	Contents PU pcs	Weight kg/PU	Shipping box PU	Item No.
SPM 6x40	Natural	6.00	40.00	6.00	1.00	200	1.33	10	960 00 3
SPM 6x80	Natural	6.00	80.00	6.00	1.00	100	0.96	10	943 11 5



Grouped support KKS

This one keeps its promises



And this proves it:

1. Replaces cable ducts
2. Easy access to the fastening point
3. Single-part system
 - Captive satellite
4. Single-handed mounting
5. Easy closing mechanism
6. Wall and ceiling mounting with base foot
7. Available with and without pre-mounted nail anchor
8. Capacity: 15 or 30 cables NYM 3 x 1.5 mm²

CHARACTERISTIC:

- Replaces cable ducts
- Easy access to the fastening point without flattening tool
- Single-part system with captive satellite
- "Single-handed" mounting
- Easy closing mechanism
- Wall and ceiling mounting with captive base section
- Available with and without pre-mounted nail anchor
- Capacity: 15 or 30 cables NYM 3 x 1.5 mm²

TECHNICAL DATA:

- Material:
 - KKS Polypropylene (PP)
 - KKS-F (flame-resistant), polyamide PA-6, halogen and silicone-free
 - Colour: KKS grey (RAL 7035), KKS-F dark grey (RAL 7030).
 - Temperature resistance:
 - 80 °C, long term
 - 130 °C, short term
 - -10 °C mounting
 - -40 °C use
 - Flame resistance according to VDE 0471/DIN IEC 695, test temperature: 960 °C

Grouped support, max. 15 cables KK15 (OZ009)

For rapid routing of cables in false ceilings on walls or ceilings using impact mounting without any additional aids.

Polypropylene

Type	Colour	No. of conductors NYM 3 x 1.5	Contents PU pcs	Weight kg/PU	Shipping box PU	Item No.
KKS 15	Grey	15.00	100	2.10	4	991 13 6



Grouped support, max. 30 cables KK30 (OZ009)

For rapid routing of cables in false ceilings on walls or ceilings using impact mounting without any additional aids.

Polypropylene

Type	Colour	No. of conductors NYM 3 x 1.5	Contents PU pcs	Weight kg/PU	Shipping box PU	Item No.
KKS 30	Grey	30.00	50	2.47	4	991 13 5



Grouped support, plastic



Grouped support with nail anchor, max. 15 cables KKS15 (OZ009)

For rapid routing of cables in false ceilings on walls or ceilings using impact mounting without any additional aids.

Polypropylene

Type	Colour	No. of conductors NYM 3 x 1.5	Dowel Ø mm	Anchor length mm	Contents PU pcs	Weight kg/PU	Shipping box PU	Item No.
KKS 15x6x55	Grey	15.00	6.00	55.00	100	2.70	1	991 13 8



Grouped support with nail anchor, max. 30 cables KKS30 (OZ009)

For rapid routing of cables in false ceilings on walls or ceilings using impact mounting without any additional aids.

Polypropylene

Type	Colour	No. of conductors NYM 3 x 1.5	Dowel Ø mm	Anchor length mm	Contents PU pcs	Weight kg/PU	Shipping box PU	Item No.
KKS 30x6x55	Grey	30.00	6.00	55.00	50	2.10	1	991 14 1



Grouped support, flame-resistant, for max. 15 cables KKS15F 5232

For rapid routing of cables in false ceilings on walls or ceilings using impact mounting without any additional aids.

Polyamide

Type	Colour	No. of conductors NYM 3 x 1.5	Contents PU pcs	Weight kg/PU	Shipping box PU	Item No.
KKS 15F	Stone grey	15.00	100	2.50	4	991 15 6



Grouped support without nail anchor, flame-resistant, for max. 30 cables KKS30F 5232

For rapid routing of cables in false ceilings on walls or ceilings using impact mounting without any additional aids.

Polyamide

Type	Colour	No. of conductors NYM 3 x 1.5	Contents PU pcs	Weight kg/PU	Shipping box PU	Item No.
KKS 30F	Stone grey	30.00	50	2.47	4	991 15 7

Grouped support with nail anchor, flame-resistant, for max. 15 cables KKS15F 5232

For rapid routing of cables in false ceilings on walls or ceilings using impact mounting without any additional aids.

Polyamide

Type	Colour	No. of conductors NYM 3 x 1.5	Dowel Ø mm	Anchor length mm	Contents PU pcs	Weight kg/PU	Shipping box PU	Item No.
KKS 15Fx6x55	Stone grey	15.00	6.00	55.00	100	3.61	1	991 13 9



Grouped support with nail anchor, flame-resistant, for max. 30 cables KKS30F 5232

For rapid routing of cables in false ceilings on walls or ceilings using impact mounting without any additional aids.

Polyamide

Type	Colour	No. of conductors NYM 3 x 1.5	Dowel Ø mm	Anchor length mm	Contents PU pcs	Weight kg/PU	Shipping box PU	Item No.
KKS 30Fx6x55	Stone grey	30.00	6.00	55.00	50	3.27	1	991 14 2



Grouped support, metal

CHARACTERISTIC:

- Replaces cable ducts in wall or ceiling mounting
- Perfect for use in false ceilings
- Fastening holes \varnothing 6 mm
- Single-part system
- Capacity 15 or 30 cables NYM 3 x 1.5 mm²
- High mechanical resistance, also in heat
- Material: Steel, strip-galvanised



Grouped support for max. 15 cables KKM15

For rapid routing of cables in false ceilings on walls or ceilings using impact mounting without any additional aids.

Steel

Type	No. of conductors NYM 3 x 1.5	Contents PU pcs	Weight kg/PU	Shipping box PU	Item No.
KKM 15	15.00	50	1.85	1	991 21 5



Grouped support for max. 30 cables KKM30

For rapid routing of cables in false ceilings on walls or ceilings using impact mounting without any additional aids.

Steel

Type	No. of conductors NYM 3 x 1.5	Contents PU pcs	Weight kg/PU	Shipping box PU	Item No.
KKM 30	30.00	25	1.55	1	991 21 6

CHARACTERISTIC:

- Replaces cable ducts in ceiling and wall mounting (also for low ceilings)
- Ideal for false ceilings
- High level of safety thanks to impact and splinter-resistant nylon (polyamide PA-6)
- High clip flexibility
- Halogen and silicone-free
- "Single-handed" mounting
- Easy opening thanks to large, fluted lips
- Available with and without pre-mounted nail anchor
- Pre-mounted nail anchor can be knocked in with a hammer and requires no other tools
- Capacity 8, 10 or 16 cables NYM 3 x 1.5 mm²

TECHNICAL DATA:

- Material:
 - Polyamide PA-6, halogen and silicone-free
 - Colour: Grey (RAL7035)
 - Temperature resistance:
 - 80 °C, long term
 - 130 °C, short term
 - - 10 °C mounting
 - - 40 °C use
 - Flame resistance according to VDE 0471/DIN IEC 695, test temperature: 960 °C
 - UV-resistant: The product can be used under UV-radiation (weathering) in both dry and warm climates and also in humid, warm climates for at least 5 to 6 years, without any change in the use properties. This also applies to outdoor use

Clamp strap, max. 8 cables KKB-F8 (OZ003)

For simple routing of cables in false ceilings using knock-in mounting without any additional aids.

Polyamide

Type	Colour	No. of conductors NYM 3 x 1.5	Width		Length	Contents PU pcs	Weight kg/PU	Shipping box PU	Item No.
			mm	mm					
KKB 8	Grey	8.00	20.00	134.00		100	1.27	5	991 10 9

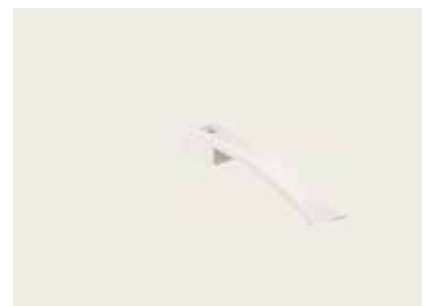

Clamp strap, max. 16 cables KKB-F10/16 (OZ003)

For simple routing of cables in false ceilings using knock-in mounting without any additional aids.

Polyamide

Type	Colour	No. of conductors NYM 3 x 1.5	Width		Length	Contents PU pcs	Weight kg/PU	Shipping box PU	Item No.
			mm	mm					
KKB 10	Grey	10.00	19.00	147.00		50	0.70	4	991 17 7
KKB 16	Grey	16.00	20.00	228.00		50	0.97	5	991 11 7



Clamp strap, plastic



PA HALOGEN

Clamp strap with nail anchor, max. 8 cables KKB-F8 (OZ002)

For simple routing of cables in false ceilings using knock-in mounting without any additional aids.
Polyamide

Type	Colour	No. of conductors NYM 3 x 1.5	Dowel Ø mm	Anchor length mm	Contents PU pcs	Weight kg/PU	Shipping box PU	Item No.
KKB 8x6x55	Grey	8.00	6.00	55.00	200	3.66	5	991 17 6



PA HALOGEN

Clamp strap with nail anchor, max. 16 cables KKB-F10/16 (OZ002)

For simple routing of cables in false ceilings using knock-in mounting without any additional aids.
Polyamide

Type	Colour	No. of conductors NYM 3 x 1.5	Dowel Ø mm	Anchor length mm	Contents PU pcs	Weight kg/PU	Shipping box PU	Item No.
KKB 10x6x55	Grey	10.00	6.00	55.00	50	0.37	4	991 17 8
KKB 16x6x55	Grey	16.00	6.00	55.00	100	2.25	5	991 16 8



PA HALOGEN

Clamp strap, flame-resistant, max. 8 cables KKB-F 8 (OZ003)

For simple routing of cables in false ceilings using knock-in mounting without any additional aids.
Polyamide

Type	Colour	No. of conductors NYM 3 x 1.5	Width mm	Length mm	Contents PU pcs	Weight kg/PU	Shipping box PU	Item No.
KKB 8F	Stone grey	8.00	20.00	134.00	100	1.27	5	991 11 0



PA HALOGEN

Clamp strap, flame-resistant, max. 16 cables KKB-F 10/16 (OZ003)

For simple routing of cables in false ceilings using knock-in mounting without any additional aids.
Polyamide

Type	Colour	No. of conductors NYM 3 x 1.5	Width mm	Length mm	Contents PU pcs	Weight kg/PU	Shipping box PU	Item No.
KKB 10F	Stone grey	10.00	19.00	147.00	50	0.37	4	991 17 9
KKB 16F	Stone grey	16.00	20.00	228.00	50	0.97	5	991 11 8

Clamp strap with nail anchor, flame-resistant, max. 8 cables KKB-F 8 (OZ002)

For simple routing of cables in false ceilings using knock-in mounting without any additional aids.
Polyamide

Type	Colour	No. of conductors NYM 3 x 1.5	Dowel Ø mm	Anchor length mm	Contents PU pcs	Weight kg/PU	Shipping box PU	Item No.
KKB 8Fx6x55	Stone grey	8.00	6.00	55.00	200	3.66	5	991 11 1



Clamp strap with nail anchor, flame-resistant, max. 16 cables KKB-F 10/16 (OZ002)

For simple routing of cables in false ceilings using knock-in mounting without any additional aids.
Polyamide

Type	Colour	No. of conductors NYM 3 x 1.5	Dowel Ø mm	Anchor length mm	Contents PU pcs	Weight kg/PU	Shipping box PU	Item No.
KKB 10Fx6x55	Stone grey	10.00	6.00	55.00	50	0.70	4	991 18 1
KKB 16Fx6x55	Stone grey	16.00	6.00	55.00	100	2.66	5	991 11 9



Hat profile rail

CHARACTERISTIC:

- Made of electrogalvanised and transparently passivated steel
- Material thickness either 1 mm (acc. to DIN EN 60715) or 1.5 mm (in accordance with DIN EN 60715)
- With and without perforation on the back



Hat profile rail, unperforated, height 7.5 mm

For use in switching and distributor cabinets, as well as in junction boxes.

Steel Electrogalvanised, transparently passivated

Type	Height mm	Width external dimension mm	Material thickness mm	Hole shape	Length mm	Contents PU pcs	Weight kg/PU	Shipping box PU	Item No.
MZ040 7,5x35UG	7.50	35.00	1.00	Without	1,000.00	1	0.34	1	981 66 0



Hat profile rail, unperforated, height 15 mm

For use in switching and distributor cabinets, as well as in junction boxes.

Steel Electrogalvanised, transparently passivated

Type	Height mm	Width external dimension mm	Material thickness mm	Hole shape	Length mm	Contents PU pcs	Weight kg/PU	Shipping box PU	Item No.
MZ038 15x35UG	15.00	35.00	1.50	Without	2,000.00	1	0.66	1	981 66 1



Hat profile rail, perforated, height 7.5 mm

For use in switching and distributor cabinets, as well as in junction boxes.

Steel Electrogalvanised, transparently passivated

Type	Height mm	Width external dimension mm	Material thickness mm	Hole shape	Length mm	Contents PU pcs	Weight kg/PU	Shipping box PU	Item No.
MZ039 7,5x35G	7.50	35.00	1.00	Long slot	2,000.00	1	0.60	1	981 66 2



Hat profile rail, perforated, height 15 mm

For use in switching and distributor cabinets, as well as in junction boxes.

Steel Electrogalvanised, transparently passivated

Type	Height mm	Width external dimension mm	Material thickness mm	Hole shape	Length mm	Contents PU pcs	Weight kg/PU	Shipping box PU	Item No.
MZ041 15x35G	15.00	35.00	1.50	Long slot	2,000.00	1	1.32	1	981 66 3

CHARACTERISTIC:

- Made of galvanised steel, either strip galvanised or hot-dip galvanised
- Material thickness between 0.75 mm and 2.0 mm
- With and without perforation on the back
- 16.5 mm slot width is perfectly suited for the use of our clamp clip with hammerhead foot
- Rail with 11 mm slot width can be broken off by hand every 10 cm and thus made the right length
- Length: 2 m

C profile rail, slot width 11 mm, with perforation, strip galvanised

For use as a support for cable or pipe routing.

Suitable for use with the pipe clamp OPDZ.

The rail has a predetermined breaking point every 10 cm. This means that the rail can be made the right length without the need for tools.

Steel Electrogalvanised

Type	Height mm	Width external dimension mm	Material thickness mm	Hole shape	Length mm	Contents PU pcs	Weight kg/PU	Shipping box PU	Item No.
MZ046 20x8G	8.00	20.00	0.75	Long slot	2,000.00	1	0.42	1	981 65 0



C profile rail, slot width 16.5 mm, without perforation, strip galvanised

For use as a support for cable or pipe routing.

Suitable for use with the clamp clip (hammerhead foot).

Steel Electrogalvanised

Type	Height mm	Width external dimension mm	Material thickness mm	Hole shape	Length mm	Contents PU pcs	Weight kg/PU	Shipping box PU	Item No.
MZ047 35x18UG	18.00	35.00	1.50	Without	2,000.00	1	1.80	1	981 65 3
MZ047 35x18G	18.00	35.00	2.00	Without	2,000.00	1	2.42	1	981 65 4



C profile rail, slot width 16.5 mm, without perforation, hot-dip galvanised

For use as a support for cable or pipe routing.

Suitable for use with the clamp clip (hammerhead foot).

Steel Hot-dip galvanised

Type	Height mm	Width external dimension mm	Material thickness mm	Hole shape	Length mm	Contents PU pcs	Weight kg/PU	Shipping box PU	Item No.
MZ049 35x18UG	18.00	35.00	2.00	Without	2,000.00	1	2.43	1	981 65 6



C profile rail



16,5

C profile rail, slot width 16.5 mm, with perforation, strip galvanized

For use as a support for cable or pipe routing.
 Suitable for use with the clamp clip (hammerhead foot).

Steel Electrogalvanised

Type	Height mm	Width external dimension mm	Material thickness mm	Hole shape	Length mm	Contents PU pcs	Weight kg/PU	Shipping box PU	Item No.
MZ046 35x18G	8.00	20.00	1.50	Long slot	2,000.00	1	1.50	1	981 65 1
MZ046 35x18G	8.00	20.00	2.00	Long slot	2,000.00	1	2.16	1	981 65 2



16,5

C profile rail, slot width 16.5 mm, with perforation, hot-dip galvanized

For use as a support for cable or pipe routing.
 Suitable for use with the clamp clip (hammerhead foot).

Steel Hot-dip galvanized

Type	Height mm	Width external dimension mm	Material thickness mm	Hole shape	Length mm	Contents PU pcs	Weight kg/PU	Shipping box PU	Item No.
MZ048 35x18G	18.00	35.00	2.00	Long slot	2,000.00	1	1.78	1	981 65 5

Clamp clip with hammerhead foot for C-profile rail

CHARACTERISTIC:

- Hot-dip galvanised up to 50 my for professional, long-term use
- With hammerhead foot for use in C profile rails of 16 mm to 17 mm slot width
- With hexagonal bolt for rapid cable or pipe fixing
- M6 screw thread, screw head with WAF 10
- 1x version with plastic pressure trough made of polypropylene, halogen-free, black

Clamp clip with hammerhead foot for C-profile rail (MZ042)

To fasten cables, empty pipes and pipes to C profile rails.

Steel Hot-dip galvanised



Type	Colour	Dimension	Contents		Shipping box	Item No.
			PU	Weight		
			pcs	kg/PU	PU	
MZ042 8-12	Black	8-12	100	3.84	1	904 03 5
MZ042 12-16	Black	12-16	100	3.82	1	904 03 6
MZ042 16-22	Black	16-22	100	4.51	1	904 03 7
MZ042 22-28	Black	22-28	100	6.24	1	904 03 8
MZ042 28-34	Black	28-34	100	7.68	1	904 03 9
MZ042 34-40	Black	34-40	50	4.13	1	904 04 0
MZ042 40-46	Black	40-46	50	5.45	1	904 04 1
MZ042 46-52	Black	46-52	50	5.95	1	904 04 2
MZ042 52-58	Black	52-58	50	7.15	1	904 04 3
MZ042 58-64	Black	58-64	25	3.90	1	904 04 4
MZ042 64-70	Black	64-70	25	4.55	1	904 04 5
MZ042 70-76	Black	70-76	25	5.15	1	904 04 6
MZ042 76-82	Black	76-82	25	5.50	1	904 04 7
MZ042 82-90	Black	82-90	25	6.55	1	904 04 8
MZ042 90-100	Black	90-100	25	6.95	1	904 04 9

Counter-trough for clamp clip

CHARACTERISTIC:

- Prevents cable damage
- Better, simpler cable alignment
- Insulates the cable from the profile rail



Counter-trough for clamp clip made of plastic (MZ043)

For safe, damage-free alignment of cables, empty pipes and pipes in the clamp clip.

Polypropylene

Type	Colour	Dimension	Contents PU pcs	Weight kg/PU	Shipping box PU	Item No.
MZ043 8-12	Black	8-12	100	0.10	27	904 00 0
MZ043 12-16	Black	12-16	100	0.13	27	904 00 1
MZ043 16-22	Black	16-22	100	0.17	27	904 00 2
MZ043 22-28	Black	22-28	100	0.22	27	904 00 3
MZ043 28-34	Black	28-34	100	0.28	27	904 00 4
MZ043 34-40	Black	34-40	50	0.16	18	904 00 5
MZ043 40-46	Black	40-46	50	0.21	18	904 00 6
MZ043 46-52	Black	46-52	50	0.21	18	904 00 7
MZ043 52-58	Black	52-58	50	0.23	18	904 00 8
MZ043 58-64	Black	58-64	25	0.13	27	904 00 9
MZ043 64-70	Black	64-70	25	0.14	27	904 01 0
MZ043 70-76	Black	70-76	25	0.16	25	904 01 1
MZ043 76-82	Black	76-82	25	0.17	25	904 01 2
MZ043 82-90	Black	82-90	25	0.22	25	904 01 3
MZ043 90-100	Black	90-100	25	0.23	25	904 01 4

CHARACTERISTIC:

- For rapid fixing of cables and pipes to steel supports
- Clamping range between 2 mm and 12 mm, depending on the version
- For cables or empty pipes with diameters between 6 mm and 32 mm, depending on the version

Support clamp for knocking in (MZ045)

For knocking onto support, used to fasten pipes and cables.

Steel

Type	Dimension	Clamping range mm	For pipe Ø mm	Contents PU pcs	Weight kg/PU	Shipping box PU	Item No.
MZ045 2/7 6-9	MZ045 2/7 6-9	2-7	6.00-9.00	100	0.50	1	904 70 0
MZ045 2/7 10-14	MZ045 2/7 10-14	2-7	10.00-14.00	100	0.50	1	904 70 1
MZ045 2/7 15-21	MZ045 2/7 15-21	2-7	15.00-21.00	100	0.60	1	904 70 2
MZ045 2/7 22-32	MZ045 2/7 22-32	2-7	22.00-32.00	100	0.70	1	904 70 3
MZ045 8/12 6-9	MZ045 8/12 6-9	8-12	6.00-9.00	100	0.50	1	904 70 4
MZ045 8/12 6-9	MZ045 8/12 6-9	8-12	10.00-14.00	100	0.50	1	904 70 5
MZ045 8/12 15-21	MZ045 8/12 15-21	8-12	15.00-21.00	100	0.60	1	904 70 6
MZ045 8/ 12 22-32	MZ045 8/ 12 22-32	8-12	22.00-32.00	100	0.70	1	904 70 7



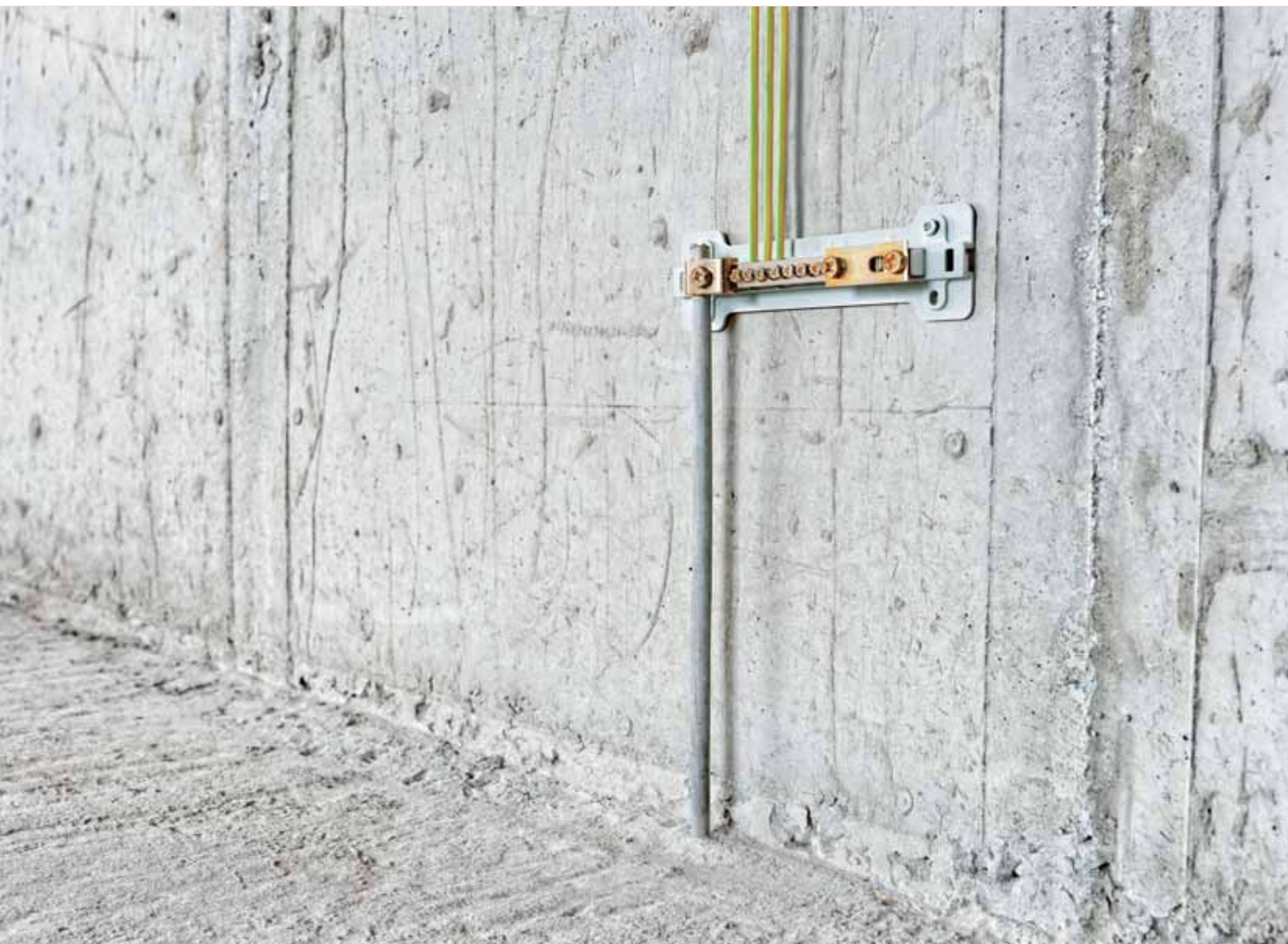

Prevention and protection, e.g. with our equipotential bonding products

4 Prevention and protection

Strip earthing clip for pipes	144
-------------------------------	-----

Earth connection clip	145
-----------------------	-----

Equipotential bonding rail	147
----------------------------	-----

Earthing rod and connector	148
----------------------------	-----

Strip earthing clip for pipes

CHARACTERISTIC:

- Clip element made of nickel-plated brass
- Tightening strap made of stainless steel
- Screws made of nickel-plated brass
- Connection for max. 2 cables, depending on version, of between 2.5 and max. 16 mm²



Strip earthing clip for pipes (EM019)

To earth pipes made of galvanised steel, copper and rustproof stainless steel in dry areas.

Stainless steel, grade 304 Hot-dip galvanised

Type	Number of cables/pipes	For cable Ø mm	For pipe Ø mm	For pipe Ø inch	Contents PU pcs	Weight kg/PU	Shipping box PU	Item No.
EM019 8-22 2.5x10	2.00	2.50-10.00	8.00-22.00	–	10	0.50	12	905 10 1
EM019 3/8-1 1/2 2.5x16	2.00	2.50-16.00	–	3/8 - 1 1/2	10	0.78	12	905 10 2
EM019 3/8-4 2.5x16	2.00	2.50-16.00	–	3/8 - 4	10	0.86	10	905 10 3

CHARACTERISTIC:

- Clip made of nickel-plated copper
- With connection terminal and cylinder screw M6 x 16 from nickel-plated brass
- For copper pipes, depending on the version, of between \varnothing 8 and 35 mm² (\varnothing 1/8 to 1 inch)
- Connection for cables of 2.5 to max. 16 mm²

Connection earthing clip for pipes (EM018)

To earth round cables.

Copper Nickel-plated

Type	For pipe \varnothing mm	For pipe \varnothing inch	Contents PU pcs	Weight kg/PU	Shipping box PU	Item No.
EM018 8-11	8.00-11.00	1/8	10	0.45	40	905 11 0
EM018 13-15	13.00-15.00	1/4	10	0.46	32	905 11 1
EM018 16-18	16.00-18.00	3/8	10	0.52	20	905 11 2
EM018 19-22	19.00-22.00	1/2	10	0.55	20	905 11 3
EM018 24-28	24.00-28.00	3/4	10	0.62	20	905 11 4
EM018 30-35	30.00-35.00	1	10	0.86	12	905 11 5



Connection clip for flat cables (earthing lug)

CHARACTERISTIC:

- Brass earthing terminal, copper-plated
- Washers made of stainless steel, electrogalvanised
- Clamping element with end thread M6, hexagonal nut M6, serrated washer and 2 cylinder bolts M5 x 8
- For cables of 2.5 to max. 16 mm²



Connection earthing clip for the bathroom (EM015)

To earth bathtubs and Jacuzzis

Brass

Type	Dimension	Contents PU pcs	Weight kg/PU	Shipping box PU	Item No.
EM015	EM015 2.5-16	10	0.57	12	905 10 5

CHARACTERISTIC:

- Base plate and cover made of polystyrene
- Two-row contact strips made of nickel-plated brass
- Screws and crossbar made of galvanised steel
- Connection options for 7 single or multi-wire conductors of up to max. 25 mm² or fine-wire cables of up to max. 16 mm², max. 2 round cables ø 8–10 mm or 1 flat conductor of up to 30 mm width and 1 round cable ø 8–10 mm

Equipotential bonding connection rail (EM021)

Suitable for compensating and preventing voltage differences and possible resulting voltage arcing (equipotential bonding).

Type	Dimension	Contents PU pcs	Weight kg/PU	Shipping box PU	Item No.
EM021 7-25	EM021 7-25	1	0.55	1	905 10 7



Earthing rod, cross profile

CHARACTERISTIC:

- Cross profile 50 x 50 x 3 mm
- All versions are hot-dip galvanised
- Connection strap version:
 - 1 through hole \varnothing 13 mm
 - 2 through holes \varnothing 11 mm
- Strip steel lug version:
 - Size 30 x 3.5 mm
 - 2 through holes \varnothing 11 mm
- Round cable lug version:
 - 2 m with \varnothing 10 mm



Earthing rod, cross profile, with connection strap (EM023)

To set up earthing systems, e.g. for antennas or building power distributors.

Steel Hot-dip galvanised

Type	Dimension	Length	Version	Contents PU	Weight	Shipping box	Item No.
		mm		pcs	kg/PU	PU	
EM023 1,0	50x50x3	1,000.00	With connection strap	1	2.40	1	999 07 9
EM023 1,5	50x50x3	1,500.00	With connection strap	1	3.65	1	999 08 0
EM023 2,0	50x50x3	2,000.00	With connection strap	5	4.80	1	999 08 1



Earthing rod, cross profile, with strip steel lug (EM025)

To set up earthing systems, e.g. for antennas or building power distributors.

Steel Hot-dip galvanised

Type	Dimension	Length	Version	Contents PU	Weight	Shipping box	Item No.
		mm		pcs	kg/PU	PU	
EM025 1,5	50x50x3	1,500.00	With strip steel lug	1	5.28	1	999 08 2
EM025 2,0	50x50x3	2,000.00	With strip steel lug	1	5.28	1	999 08 3



Earthing rod, cross profile, with round conductor lug (EM024)

To set up earthing systems, e.g. for antennas or building power distributors.

Steel Hot-dip galvanised

Type	Dimension	Length	Version	Contents PU	Weight	Shipping box	Item No.
		mm		pcs	kg/PU	PU	
EM024 1,5	50x50x3	1,500.00	With round conductor lug	1	4.87	1	999 08 4
EM024 2,0	50x50x3	2,000.00	With round conductor lug	1	6.11	1	999 08 5

CHARACTERISTIC:

- Pressure trough made of steel, hot galvanised
- Incl. pre-mounted clamping screw, nut and toothed washer
- For round cables, \varnothing 8–10mm

Connector for earthing rod (EM014)

Connection terminal for round cable \varnothing 8 to 10 mm, clamping bolt, nut and sprung washer, incl. pre-mounted pressure trough made of hot galvanised steel.

Steel

Type	Contents PU pcs	Weight kg/PU	Shipping box PU	Item No.
EM014	100	5.90	1	905 10 6





5 Appendix

Pictogram explanation	152
-----------------------	-----

Alphabetical table of contents	154
--------------------------------	-----





Numeric directory	158
-------------------	-----

Type listing	162
--------------	-----



Terms and conditions of sale and delivery	171
---	-----

Pictogram explanation



















General information

	Do not use continuously outdoors
	Can be used outdoors
	New products
	Halogen-free
	UV-resistant





Conformity symbol

	Communautés Européennes, EC declaration of conformity according to EC directives
	RoHS-conformant





Nail head

	Flat head, embossed
	Flat head, smooth
	Rounded head
	Half rounded head
	Half rounded head, flat
	Flat rounded head
	Countersunk head
	Countersunk head, embossed
	Compression head
	Panel head
	Panhead
	Washer head
	Head for shot nails
	Plastic head
	M4 thread
	M6 thread
	M7 thread
	M8 thread



Nail shank

	Smooth shank
	Fluted shank
	Interrupted fluted shaft
	Embossed shank
	Fluted shaft (ring shaft)





Nail shank

	Screw shank with 5° inclination
	Screw shank with 27.5° inclination
	Screw shank with 60° inclination
	Screw shank with 65° inclination







Nail tip

	Diamond tip
	Ballistic tip
	Round tip







Screw drive

	Philips screw (Pozi 2)
	Combination Philips
	Slot
	Torx
	Hexagon head

Anchor collar

	Without collar
	Narrow collar
	Wide collar
	Mushroom collar
	Countersunk collar
	Wide countersunk collar
	Narrow countersunk collar



Shrink rate

	Shrink rate 2:1
	Shrink rate 3:1
	Shrink rate 4:1
	Shrink rate with inner adhesive 2:1
	Shrink rate with inner adhesive 3:1
	Shrink rate with inner adhesive 4:1



Protection type

	Protection rating IP54
---	------------------------



Voltage

	Nominal voltage 380 V
	Nominal voltage 400 V













Voltage

 450 V	Nominal voltage 450 V
 600 V	Nominal voltage 600 V
 650 V	Nominal voltage 650 V











Rail

 11	Slot width 11 mm for C profile
 16,5	Slot width 16.5 mm for C profile
 H	Hammerhead foot for C profile







Material

 PA	Polyamide
 NYLON	Polyamide 6.6
 PC	Polycarbonate
 PE	Polyethylene
 PE-HD	Polyethylene High Density (HDPE)
 PEX	Polyolefin
 PP	Polypropylene
 PS	Polystyrene
 PTFE	Polytetrafluoroethylene (Teflon)
 PVC	Polyvinylchloride
 ABS	Acrylonitrile butadiene styrene
 IIR	Butyl rubber
 VISKOSE	Viscose fabric























Test marks

 CEBEC	Österreichischer Verband für Elektrotechnik
 VDE	Verband der Elektrotechnik, Elektronik und Informationstechnik
 Keuring van Elektrotechnische Materialen te Arnhem	
 KIWA	KIWA quality mark
 ESTI	Eidgenössisches Starkstrominspektorat ESTI
 SEMKO	Svenska Elektriska Materielkontrollanstalten (SEMKO)
 AFNOR	Norme Française (AFAQ AFNOR)
 NEMKO	Norges Elektriske Materiekkontroll (NEMKO)
 FIMKO	Finlands Material Kontroll (FIMKO)
 Zkušební Ústav	Elektrotechnický Zkušební Ústav
 DEMKO	Dansk Elektrisk Materiel Kontrol (DEMKO)

Test marks

 CEBEC	Comité Electrotechnique Belge/Belgisch Elektrotechnisch Comité (CEBEC)
 BBJ-SEP	Stowarzyszenie Elektryków Polskich (BBJ-SEP)
 AENOR	Asociación Española de Normalización y Certificación (AENOR)
 GOST-R	Государственные стандарты Российской Федерации (ГОСТ-Р) Gosudarstvennyi standarty Rossiiskoi Federatsii (GOST-R)
 UL	Underwriters Laboratories
 UL Recognized Component Mark	
 ENEC	European Norms Electrical Certification (ENEC) 11 = Country code for ÖVE (Austria)

Contents, packing unit (PU)

 0,4 kg	0.4 kg
 1 kg	1 kg
 2,5 kg	2.5 kg
 5 kg	5 kg
 1 St./Pcs	1 piece
 10 St./Pcs	10 pieces
 20 St./Pcs	20 pieces
 25 St./Pcs	25 pieces
 30 St./Pcs	30 pieces
 40 St./Pcs	40 pieces
 50 St./Pcs	50 pieces
 100 St./Pcs	100 pieces
 125 St./Pcs	125 pieces
 150 St./Pcs	150 pieces
 175 St./Pcs	175 pieces
 200 St./Pcs	200 pieces
 250 St./Pcs	250 pieces
 300 St./Pcs	300 pieces
 400 St./Pcs	400 pieces
 500 St./Pcs	500 pieces
 700 St./Pcs	700 pieces
 1.000 St./Pcs	1,000 pieces

Alphabetical table of contents

2

- 2:1 heat-shrinkable sleeve, thin-walled, , 83
black/coloured, in assorted box (OZ071)
- 2:1 heat-shrinkable sleeve, thin-walled, black/yellow-, 83
green, in assorted box (OZ072)
- 2:1 heat-shrinkable sleeve, thin-walled, in dispensing, 82
box (OZ071)
- 2-way fastening base for cable ties, black (OZ067), 60
- 2-way fastening base for cable ties, natural (OZ067), 60

3

- 3:1 heat-shrinkable sleeve, double-walled, 1 m long, 85
(OZ070)
- 3:1 heat-shrinkable sleeve, thin-walled, 1 m long, 84
(OZ070)
- 3:1 heat-shrinkable sleeve, thin-walled, , 84
black/coloured, in assorted box (OZ072)

4

- 4:1 heat-shrinkable sleeve, double-walled, 1 m long, 85
(OZ070)

A

- Adapter M18 - M16 (GE008), 88

B

- Box lamp-wire connector, open on both sides, 77
(EM008)
- Box lamp-wire connector, open on one side (EM008), 77

C

- C profile rail, slot width 11 mm, with perforation, strip, 137
galvanised
- C profile rail, slot width 16.5 mm, with perforation,, 138
hot-dip galvanised
- C profile rail, slot width 16.5 mm, with perforation,, 138
strip galvanised
- C profile rail, slot width 16.5 mm, without perforation,, 137
hot-dip galvanised
- C profile rail, slot width 16.5 mm, without perforation,, 137
strip galvanised
- Cable tie pliers, automatic cut-off (OZ068), 70
- Cable tie pliers, manual cut-off (OZ069), 70
- Cable tie, standard, natural (OZ066), 59
- Cable tie, standard, UV-resistant, black (OZ066), 59
- Cassette, woven tape, plastic (MZ030), 64
- Ceiling hook (SC019), 32
- Centring drill (GE009), 88
- Centring drill, conical (GE010), 88
- Centring tip for suction unit (GE005), 87
- Chipboard screw, countersunk head with Philips head, 34
(SC015)
- Chipboard screw, panhead with combination Philips, 34-35
head (SC016)
- Chipboard screw, panhead with Torx (SC017), 35
- Clamp clip with hammerhead foot for C-profile rail, 139
(MZ042)
- Clamp clip, plastic with nail anchor ø5 mm SCP, 106
(CP000)
- Clamp clip, plastic with nail anchor ø6 mm SCP, 107
(CP000)
- Clamp clip, plastic with nail anchor SCP DUO, 108
(CP000)
- Clamp clip, plastic without nail anchor SCP-M6, 106
(CP000)
- Clamp clip, plastic without nail anchor SCP-M6 DUO, 108
(CP000)
- Clamp strap with nail anchor, flame-resistant, max. 16, 135
cables KKB-F 10/16 (OZ002)
- Clamp strap with nail anchor, flame-resistant, max. 8, 135
cables KKB-F 8 (OZ002)
- Clamp strap with nail anchor, max. 16 cables KKB-, 134
F10/16 (OZ002)
- Clamp strap with nail anchor, max. 8 cables KKB-F8, 134
(OZ002)

C

- Clamp strap, flame-resistant, max. 16 cables KKB-F, 134
10/16 (OZ003)
- Clamp strap, flame-resistant, max. 8 cables KKB-F 8, 134
(OZ003)
- Clamp strap, max. 16 cables KKB-F10/16 (OZ003), 133
- Clamp strap, max. 8 cables KKB-F8 (OZ003), 133
- Connecting loop STS, curved (OZ050), 95
- Connecting loop STS, straight (OZ050), 95
- Connection earthing clip for pipes (EM018), 145
- Connection earthing clip for the bathroom (EM015), 146
- Connector for earthing rod (EM014), 149
- Counter-trough for clamp clip made of plastic, 140
(MZ043)
- Crimp clamp, I type (EM022), 80
- Crimp clamp, T type (EM022), 80

D

- Device screw, countersunk head, with combination, 36
Philips (SC024)
- Diamond cutting disc MATRIX (GE013), 89
- Diamond cutting disc PREMIUM (GE012), 89
- Diamond cutting disc UNI (GE011), 89
- Diamond dry core drill MATRIX (GE003), 86
- Diamond dry core drill PREMIUM (GE002), 86
- Diamond dry core drill UNIT (GE001), 86
- DKS nail disc with nail (KG014), 104
- Double flat-head cable tie (OZ077), 61

E

- Earthing rod, cross profile, with connection strap, 148
(EM023)
- Earthing rod, cross profile, with round conductor lug, 148
(EM024)
- Earthing rod, cross profile, with strip steel lug, 148
(EM025)
- Empty pipe sleeve "Connect-Ring" (OZ056), 81
- Equipotential bonding connection rail (EM021), 147

F

- Fastening clip OPDZ STP (OZ040), 121
- Fastening clip OPDZ TF (OZ055), 122
- Fastening clip SCO (OZ004), 117
- Fastening clip, double, 1-hole, ø 5.5 mm, (MZ019), 125
- Fastening clip, single, 1-hole, ø 5.5 mm, width 15 mm, 123
(MZ020)
- Fastening clip, single, 1-hole, ø 5.5 mm, width 20 mm, 123
(MZ020)
- Fastening clip, single, 1-hole, ø 6.5 mm, (MZ031), 123
- Fastening clip, single, 2-hole, ø6.5 mm (MZ032), 124
- Fastening tie, screw-on (OZ073), 62
- Fixpin knock-in anchor, lengthwise fluting, large collar, 40
(KS199)
- Fixpin knock-in anchor, lengthwise fluting, large collar,, 40
case set
- Fixpin knock-in anchor, lengthwise fluting, large collar,, 40
case set and installation strip
- Fixpin knock-in anchor, lengthwise fluting, large collar,, 41
predetermined breaking point (KS284)
- Fixpin knock-in anchor, lengthwise fluting, small, 41
collar, predetermined breaking point (KS243)
- Fixpin knock-in anchor, smooth, small collar (KS233), 39
- Fixpin knock-in anchor, smooth, small collar, case set, 39
- Flat head cable tie (OZ077), 61
- Flattener with hand protection (KS207), 40, 42, 68
- Flattener with hand protection for breakable Fixpin, 68
(KS246)
- Flattener without hand protection (KS170), 37, 68
- Flattener without hand protection with slot (KS221), 69
- Full material anchor with collar (PG038), 43
- Full material anchor without collar (PG037), 43
- Full plastic anchor for cable ties VKKH (VK004), 56
- Full plastic anchor for cable ties VKKL (VK002), 56
- Full plastic anchor VK, black RAL9011 (VK001), 54

F

Full plastic anchor VK, brown RAL8004 (VK001), 55
 Full plastic anchor VK, grey RAL7035 (VK001), 54
 Full plastic anchor VK, light brown RAL8001 (VK001), 55
 Full plastic anchor VK, white RAL9010 (VK001), 54

G

Gips-Fixx, metal L (MZ026), 53
 Gips-Fixx, metal XL (MZ028), 53
 Grooved nail with plastic head V4A [AISI316], 27 (RV038)
 Grooved nail, half rounded head V2A [AISI304], 28 according to construction products ordinance (RV034)
 Grooved nail, half rounded head V4A [AISI316], 29 according to construction products ordinance (RV037)
 Grouped support for max. 15 cables KKM15, 132
 Grouped support for max. 30 cables KKM30, 132
 Grouped support with nail anchor, flame-resistant, for, 131 max. 15 cables KKS15F 5232
 Grouped support with nail anchor, flame-resistant, for, 131 max. 30 cables KKS30F 5232
 Grouped support with nail anchor, max. 15 cables, 130 KKS15 (OZ009)
 Grouped support with nail anchor, max. 30 cables, 130 KKS30 (OZ009)
 Grouped support without nail anchor, flame-resistant,, 130 for max. 30 cables KKS30F 5232
 Grouped support, flame-resistant, for max. 15 cables, 130 KKS15F 5232
 Grouped support, max. 15 cables KK15 (OZ009), 129
 Grouped support, max. 30 cables KK30 (OZ009), 129

H

Hammer plug KPA, countersunk collar, countersunk, 49-50 head
 Hand-held nail, rounded head and disc, glossy-, 18 galvanised (KG003)
 Hat profile rail, perforated, height 15 mm, 136
 Hat profile rail, perforated, height 7.5 mm, 136
 Hat profile rail, unperforated, height 15 mm, 136
 Hat profile rail, unperforated, height 7.5 mm, 136
 Hex-head wood screw DIN 571 (SC018), 33
 Hook nail, fluted, round (KS138), 20
 Hook nail, smooth, round (B059), 19
 Hook nail, smooth, round, unhardened (B058), 19

I

Impu steel nail (KG011), 21
 Impu steel nail, blue annealed (KG010), 21
 Insulating tape, electrical, standard (EM027), 65
 Insulating tape, electrical, weatherproof (EM028), 65
 ISO grip clip for 1 cable (OZ062), 115
 ISO grip clip for 2 cables (OZ063), 115
 ISO pressure clip for 1 cable (OZ060), 114
 ISO pressure clip for 2 cables (OZ061), 114

J

Joint expansion set for pipe clip KPA (M005), 110
 Junction box 10 (EM009), 74
 Junction box 12 (EM011), 75
 Junction box 16 (EM020), 75
 Junction box 7 (EM010), 74

K

KLS nail disc with nail (KG006), 102
 KLS nail disc without nail (KG005), 102
 Knock-in anchor M6 (KS266,KS274,KS282), 37
 Knotted chain (MZ050), 67

L

Lamp-wire connector (EM003 to EM006), 76

M

M6 anchor (KS266,KS274,KS282), 120
 M6 bushing for pipe clip UNO-LB/-LBD (M007), 112
 Metal installation strap, plastic-covered (MZ024), 63
 Metal installation strap, plastic-covered, in box, 63 (MZ030)
 Metal installation strap, straight (MZ023), 63
 Metal installation strap, straight, in plastic cassette, 63 (MZ029)

N

Nail anchor SP 8/70 MZ for pipe clamp UNO-LB/-, 113 LBD (OZ023)
 Nail anchor SPM M6 (PL029), 114-115, 120
 Nail anchor SPS 8*100 (OZ011), 109
 Nail tie, half rounded head, large NAB (KS186), 30
 Nail tie, half rounded head, small NAS (KS198), 30
 Natural rubber adhesive tape, self-sealing (EM029), 66

O

OKS nail disc with nail (KG008), 103
 OKS nail disc without nail (KG008), 103

P

Panel pin, coarse, countersunk head (KS209), 31
 Panel pin, countersunk head (KS258, KS259), 31
 Pipe clamp KPA grey (OZ006), 109
 Pipe clamp KPA white (OZ006), 109
 Pipe clamp UNO-LB (OZ035), 112
 Pipe clamp UNO-LBD with rubber noise dampener, 112 (OZ034)
 Pipe clamp, OPDZ 5 mm dark grey KEMA (OZ043), 119
 Pipe clamp, OPDZ 5 mm grey (OZ045), 119
 Pipe clamp, OPDZ 6 mm cream KEMA (OZ043), 119
 Pipe clamp, OPDZ 6 mm grey (OZ029), 118-119
 Plasterboard anchor, plastic, turn-in (PG041), 53
 Plasterboard anchor, ZAMAK, turn-in (PG042), 53
 PTFE thread sealing tape (EM031), 66
 Push-fit anchor for fastening tie M6/M7 (PG037), 62
 Push-in hook STD (OZ054), 92
 Push-in hook STH ø6 mm (OZ065), 93
 Push-in hook STH ø8 mm (OZ078), 93
 Push-in hook STHD ø6 mm (OZ064), 93
 Push-in hook STHD ø8 mm (OZ078), 94

R

RKK nail clamp, grey (CC001), 96
 RKK nail clamp, white (CC001), 96
 RKS nail disc with nail (KG007), 101
 RKS nail disc without nail (KG007), 101

S

S hook (MZ051), 67
 Screw nail, 60° thread (PR089), 23
 Screw nail, 65° thread (PR155), 23
 Screw nail, rounded head V2A [AISI 304] (ZZ023), 26
 Screwless terminal, 3-pin (EM001), 78
 Screwless terminal, 5-pin (EM002), 78
 Selvege pin, compression head, V2A [AISI304], 26 (RV014)
 Selvege pin, smooth, compression head, 17 (KS150/KS151)
 Selvege pin, smooth, compression head, blue, 17 annealed (KS076/KS085)
 Shot nail, shot head and disc, mechanical galvanised, 18 (KG001)
 Siku nail (KG013), 22
 Siku nail, blue annealed (KG012), 22
 SKK nail clamp, cream (CC008), 99
 SKK nail clamp, grey (CC008), 98
 SKK nail clamp, natural (CC008), 98
 SKK nail clamp, white (CC008), 98

Alphabetical table of contents

S

SKKD nail clamp, cream (CC009), 99
SKKD nail clamp, grey (CC009), 99
SKKD nail clamp, natural (CC009), 99
Spacer clip straight slot (MZ033), 126
Spacer clip thread M6 (MZ034), 127
Spacer for pipe clamp KPA grey (OZ011), 110
Spacer for pipe clamp KPA white (OZ011), 110
Speedplug SP, flat collar, cylinder head, 46
Speedplug SPA2, flat collar, cylinder head, 49
Speedplug SP-E, flat collar, cylinder head, 46
Speedplug SPHZ, wide collar, countersunk head, 49
Speedplug SPKK, countersunk collar, countersunk, 47 head
Speedplug SPM M6, countersunk collar, countersunk, 47 head
Speedplug SPM M7, countersunk collar, countersunk, 48, 62 head
Speedplug SPM M8, countersunk collar, countersunk, 48 head
Speedplug SPM, countersunk collar, countersunk, 127 head
Speedplug SPP, countersunk collar, countersunk, 48 head
Speedplug SPTB, mushroom collar, mushroom head, 49
Sprung-hinged anchor with ceiling hook (SC023), 57
Sprung-hinged anchor without ceiling hook (SC022), 57
Steel nail, continuously fluted, disc head (KS112), 16
Steel nail, fluted, countersunk head (KS153/KS002), 15
Steel nail, smooth, countersunk head (KS111), 13
Steel nail, smooth, countersunk head, ballistic head,, 14 galvanised (KS148)
Steel nail, smooth, countersunk head, blue annealed, 12 (KS006)
Steel nail, smooth, half flat rounded head, blue, 11 annealed (KS008)
Steel nail, smooth, rounded head (KC014), 12
Steel nail, smooth, rounded head (KC110/KS123), 11
Steel nail, smooth, rounded head, blue annealed, 10-11 (KC004/KS084)
Steel wall hook nail, smooth, square, blue annealed, 19 (KS132)
Strip earthing clip for pipes (EM019), 144
Strip for pipe clamp UNO-LB/-LBD (OZ023), 112
Suction unit (GE004), 87
Support clamp for knocking in (MZ045), 141
Support shaft SDS+ (GE007), 87
Support shaft, hexagonal (GE006), 87

T

Tensioner for pipe clamp UNO-LB/-LBD (HG001), 113
Tilting anchor with ceiling hook (SC021), 58
Tilting anchor without ceiling hook (SC020), 58
Total-Fixx TF, flat collar, cylinder head, 52

U

Universal (cavity wall) anchor for screw with collar, 44 (PG040)
Universal (cavity wall) anchor without collar (PG039), 43

V

Viscose adhesive tape, double-sided (EM030), 66

W

Wire nail, compression head (ME003), 24
Wire nail, flat head V2A [AISI304] (RV013), 27
Wire nail, flat head V2A [AISI304] according to, 28 construction products ordinance (RV013)
Wire nail, flat head, embossed (ME002), 25
Wire nail, flat rounded head (ME004), 24
Wire nail, flat rounded head V2A [AISI304] (RV001), 26
Wire nail, rounded head V2A [AISI304] according to, 28 construction products ordinance (RV001)

W

WKK nail clamp with nail (CC006), 97
WKK nail clamp without nail (CC005), 97
Woven tape, plastic, black (MZ027), 64
Woven tape, plastic, grey (MZ027), 64

Numeric directory

Structure of the GTIN: Country code **87** Manufacturer code **1367** Individual GTIN **5647589**

GTIN	Item no.	Page	GTIN	Item no.	Page	GTIN	Item no.	Page	GTIN	Item no.	Page
8008996	900 89 9	123	8040118	904 01 1	140	8043591	904 35 9	34	8044451	904 44 5	32
			8040125	904 01 2	140	8043607	904 36 0	34	8044468	904 44 6	32
8009009	900 90 0	123	8040132	904 01 3	140	8043614	904 36 1	34	8044475	904 44 7	58
8009016	900 90 1	123	8040149	904 01 4	140	8043621	904 36 2	34	8044482	904 44 8	58
8009023	900 90 2	123	8040354	904 03 5	139	8043638	904 36 3	34	8044499	904 44 9	58
8009030	900 90 3	123	8040361	904 03 6	139	8043645	904 36 4	34	8044505	904 45 0	57
8009047	900 90 4	123	8040378	904 03 7	139	8043652	904 36 5	34	8044512	904 45 1	57
8009054	900 90 5	125	8040385	904 03 8	139	8043669	904 36 6	34	8044529	904 45 2	58
8009078	900 90 7	125	8040392	904 03 9	139	8043676	904 36 7	34	8044536	904 45 3	58
8009092	900 90 9	123	8040408	904 04 0	139	8043683	904 36 8	34	8044543	904 45 4	58
8009108	900 91 0	125	8040415	904 04 1	139	8043690	904 36 9	34	8044550	904 45 5	114
8009115	900 91 1	125	8040422	904 04 2	139	8043706	904 37 0	34	8044567	904 45 6	114
8009139	900 91 3	125	8040439	904 04 3	139	8043713	904 37 1	34	8044574	904 45 7	115
8009184	900 91 8	123	8040446	904 04 4	139	8043720	904 37 2	34	8044581	904 45 8	115
8009191	900 91 9	123	8040453	904 04 5	139	8043737	904 37 3	34	8044598	904 45 9	21
8009207	900 92 0	123	8040460	904 04 6	139	8043744	904 37 4	34	8044604	904 46 0	21
8009214	900 92 1	125	8040477	904 04 7	139	8043751	904 37 5	34	8044611	904 46 1	21
8009221	900 92 2	125	8040484	904 04 8	139	8043768	904 37 6	34	8044628	904 46 2	21
8009238	900 92 3	125	8040491	904 04 9	139	8043775	904 37 7	34	8044635	904 46 3	21
8009245	900 92 4	125				8043782	904 37 8	34	8044642	904 46 4	21
8009252	900 92 5	63	8042501	904 25 0	80	8043799	904 37 9	34	8044659	904 46 5	21
8009269	900 92 6	63	8042518	904 25 1	80	8043805	904 38 0	34	8044666	904 46 6	21
8009276	900 92 7	63	8042525	904 25 2	80	8043812	904 38 1	34	8044673	904 46 7	21
8009283	900 92 8	64	8042532	904 25 3	80	8043829	904 38 2	34	8044680	904 46 8	21
8009344	900 93 4	63	8042549	904 25 4	80	8043836	904 38 3	34	8044697	904 46 9	21
8009351	900 93 5	63	8042600	904 26 0	80	8043843	904 38 4	34	8044703	904 47 0	21
8009368	900 93 6	63	8042617	904 26 1	80	8043850	904 38 5	34	8044710	904 47 1	21
8009375	900 93 7	63	8042624	904 26 2	80	8043867	904 38 6	34	8044727	904 47 2	21
8009382	900 93 8	63	8042631	904 26 3	80	8043874	904 38 7	35	8044734	904 47 3	21
8009391	900 93 9	64	8042648	904 26 4	80	8043881	904 38 8	35	8044741	904 47 4	21
8009405	900 94 0	63				8043898	904 38 9	35	8044758	904 47 5	22
8009474	900 94 7	63	8043003	904 30 0	126	8043904	904 39 0	35	8044765	904 47 6	22
8009481	900 94 8	63	8043010	904 30 1	126	8043911	904 39 1	35	8044772	904 47 7	22
8009559	900 95 5	64	8043027	904 30 2	126	8043928	904 39 2	35	8044789	904 47 8	22
8009566	900 95 6	64	8043034	904 30 3	126	8043935	904 39 3	35	8044796	904 47 9	22
8009610	900 96 1	81	8043041	904 30 4	126	8043942	904 39 4	35	8044802	904 48 0	22
8009658	900 96 5	81	8043058	904 30 5	126	8043959	904 39 5	35	8044819	904 48 1	22
8009696	900 96 9	81	8043065	904 30 6	126	8043966	904 39 6	35	8044826	904 48 2	22
8009719	900 97 1	81	8043072	904 30 7	126	8043973	904 39 7	35	8044833	904 48 3	22
			8043089	904 30 8	127	8043980	904 39 8	35	8044840	904 48 4	22
8010005	901 00 0	123	8043096	904 30 9	127	8043997	904 39 9	35	8044857	904 48 5	22
8010012	901 00 1	123	8043102	904 31 0	127				8044864	904 48 6	22
8010029	901 00 2	123	8043119	904 31 1	127	8044000	904 40 0	35	8044871	904 48 7	22
8010036	901 00 3	123	8043126	904 31 2	127	8044017	904 40 1	35	8044888	904 48 8	22
8010043	901 00 4	123	8043133	904 31 3	127	8044024	904 40 2	35	8044895	904 48 9	22
8010050	901 00 5	123	8043140	904 31 4	127	8044031	904 40 3	35			
8010067	901 00 6	123	8043157	904 31 5	127	8044048	904 40 4	35	8045908	904 59 0	61
8010074	901 00 7	123	8043164	904 31 6	127	8044055	904 40 5	35	8045915	904 59 1	61
8010081	901 00 8	123	8043171	904 31 7	127	8044062	904 40 6	35	8045922	904 59 2	61
8010098	901 00 9	123	8043188	904 31 8	127	8044079	904 40 7	35	8045939	904 59 3	61
8010104	901 01 0	123	8043195	904 31 9	127	8044086	904 40 8	35			
8010111	901 01 1	123	8043201	904 32 0	127	8044093	904 40 9	35	8046004	904 60 0	59
8010128	901 01 2	123	8043218	904 32 1	127	8044109	904 41 0	35	8046011	904 60 1	59
8010135	901 01 3	123	8043225	904 32 2	127	8044116	904 41 1	35	8046028	904 60 2	59
8010401	901 04 0	124	8043232	904 32 3	127	8044123	904 41 2	35	8046035	904 60 3	59
8010418	901 04 1	124	8043249	904 32 4	127	8044130	904 41 3	35	8046042	904 60 4	59
8010425	901 04 2	124	8043256	904 32 5	127	8044147	904 41 4	35	8046059	904 60 5	59
8010432	901 04 3	124	8043263	904 32 6	127	8044154	904 41 5	35	8046066	904 60 6	59
8010449	901 04 4	124	8043270	904 32 7	127	8044161	904 41 6	35	8046073	904 60 7	59
8010456	901 04 5	124	8043287	904 32 8	127	8044178	904 41 7	35	8046080	904 60 8	59
8010463	901 04 6	124	8043294	904 32 9	127	8044185	904 41 8	35	8046097	904 60 9	59
8010470	901 04 7	124	8043300	904 33 0	127	8044192	904 41 9	35	8046103	904 61 0	59
8010487	901 04 8	124	8043317	904 33 1	127	8044208	904 42 0	35	8046110	904 61 1	59
			8043324	904 33 2	78	8044215	904 42 1	35	8046127	904 61 2	59
8011835	901 18 3	113	8043331	904 33 3	78	8044222	904 42 2	35	8046134	904 61 3	59
			8043362	904 33 6	76	8044239	904 42 3	35	8046141	904 61 4	59
8030096	903 00 9	40	8043379	904 33 7	76	8044246	904 42 4	35	8046158	904 61 5	59
8030102	903 01 0	42	8043386	904 33 8	76	8044253	904 42 5	35	8046165	904 61 6	59
			8043393	904 33 9	76	8044260	904 42 6	35	8046172	904 61 7	59
8035121	903 51 2	37	8043409	904 34 0	77	8044277	904 42 7	33	8046189	904 61 8	59
8035169	903 51 6	37	8043416	904 34 1	77	8044284	904 42 8	33	8046196	904 61 9	59
8035183	903 51 8	69	8043430	904 34 3	74	8044291	904 42 9	33	8046301	904 63 0	60
			8043430	904 34 4	74	8044307	904 43 0	33	8046318	904 63 1	60
8036005	903 60 0	70	8043454	904 34 5	75	8044314	904 43 1	33	8046325	904 63 2	60
8036012	903 60 1	70	8043461	904 34 6	34	8044321	904 43 2	33	8046332	904 63 3	60
			8043478	904 34 7	34	8044338	904 43 3	33			
8040002	904 00 0	140	8043485	904 34 8	34	8044345	904 43 4	33	8047001	904 70 0	141
8040019	904 00 1	140	8043492	904 34 9	34	8044352	904 43 5	33	8047018	904 70 1	141
8040026	904 00 2	140	8043508	904 35 0	34	8044369	904 43 6	33	8047025	904 70 2	141
8040033	904 00 3	140	8043515	904 35 1	34	8044376	904 43 7	33	8047032	904 70 3	141
8040040	904 00 4	140	8043522	904 35 2	34	8044383	904 43 8	33	8047049	904 70 4	141
8040057	904 00 5	140	8043539	904 35 3	34	8044390	904 43 9	33	8047056	904 70 5	141
8040064	904 00 6	140	8043546	904 35 4	34	8044406	904 44 0	3			

GTIN	Item no.	Page	GTIN	Item no.	Page	GTIN	Item no.	Page	GTIN	Item no.	Page	GTIN	Item no.	Page
8051039	905 10 3	144	8276708	927 67 0	19	8317043	931 70 4	47	8392125	939 21 2	13			
8051053	905 10 5	146	8276715	927 67 1	19	8317081	931 70 8	47	8392200	939 22 0	13			
8051060	905 10 6	149	8276722	927 67 2	19	8317128	931 71 2	47	8392392	939 23 9	13			
8051077	905 10 7	147	8276746	927 67 4	19	8317203	931 72 0	47	8392477	939 24 7	13			
8051107	905 11 0	145	8276760	927 67 6	19	8317234	931 72 3	47	8392552	939 25 5	13			
8051114	905 11 1	145				8317258	931 72 5	47	8392750	939 27 5	13			
8051121	905 11 2	145	8283379	928 33 7	19	8317265	931 72 6	47						
8051138	905 11 3	145	8283751	928 37 5	19	8317395	931 73 9	47	8394235	939 42 3	13			
8051145	905 11 4	145	8283850	928 38 5	19	8317418	931 74 1	47	8394310	939 43 1	13			
8051152	905 11 5	145	8283935	928 39 3	19	8317463	931 74 6	47	8394587	939 45 8	13			
8051213	905 12 1	43				8317470	931 74 7	47	8394662	939 46 6	13			
8051220	905 12 2	43	8284208	928 42 0	19	8317531	931 75 3	47	8394747	939 47 4	13			
8051237	905 12 3	43	8284222	928 42 2	19	8317555	931 75 5	47	8394822	939 48 2	13			
8051244	905 12 4	43							8394907	939 49 0	13			
8051251	905 12 5	43	8298151	929 81 5	10	8319153	931 91 5	15						
8051268	905 12 6	43	8298236	929 82 3	10	8319238	931 92 3	15	8395034	939 50 3	13			
8051275	905 12 7	43	8298311	929 83 1	10	8319313	931 93 1	15	8395119	939 51 1	13			
8051282	905 12 8	43	8298588	929 85 8	10	8319580	931 95 8	15						
8051299	905 12 9	43	8298663	929 86 6	10	8319665	931 96 6	15	8403609	940 36 0	11			
8051305	905 13 0	43	8298748	929 87 4	10	8319740	931 97 4	15						
8051312	905 13 1	43	8298823	929 88 2	10	8319900	931 99 0	15	8408383	940 83 8	17			
8051329	905 13 2	44	8298908	929 89 0	10									
8051336	905 13 3	44				8320005	932 00 0	109	8415237	941 52 3	26			
8051343	905 13 4	44	8299035	929 90 3	10	8320012	932 00 1	109						
8051350	905 13 5	44	8299110	929 91 1	10	8320029	932 00 2	109	8420002	942 00 0	65			
8051367	905 13 6	44	8299462	929 94 6	10	8320074	932 00 7	109	8420019	942 00 1	65			
8051374	905 13 7	44	8299547	929 95 4	10	8320081	932 00 8	109	8420026	942 00 2	65			
8051381	905 13 8	53	8299707	929 97 0	10	8320241	932 02 4	110	8420035	942 00 3	65			
8051398	905 13 9	53	8299974	929 99 7	10	8320265	932 02 6	110	8420042	942 00 4	65			
						8320289	932 02 8	109	8420059	942 00 5	65			
8055044	905 50 4	85	8300151	930 01 5	10	8320302	932 03 0	110	8420066	942 00 6	66			
8055051	905 50 5	85	8300236	930 02 3	10	8320883	932 08 8	15	8420103	942 00 7	66			
8055068	905 50 6	85				8320906	932 09 0	95	8420080	942 00 8	66			
8055075	905 50 7	85	8302001	930 20 0	36	8320913	932 09 1	95						
8055082	905 50 8	85	8302018	930 20 1	36	8320920	932 09 2	95	8431152	943 11 5	47			
8055099	905 50 9	85	8302025	930 20 2	36	8320968	932 09 6	15						
8055105	905 51 0	85	8302506	930 25 0	10				8432036	943 20 3	15			
8055112	905 51 1	85	8302698	930 26 9	12	8321101	932 11 0	15	8432975	943 29 7	11			
8055129	905 51 2	85	8302773	930 27 7	12	8321170	932 11 7	15						
8055136	905 51 3	82	8302858	930 28 5	12	8332121	932 12 5	15	8433187	943 31 8	11			
8055143	905 51 4	82	8302933	930 29 3	12	8321330	932 13 3	15	8433262	943 32 6	11			
8055150	905 51 5	82				8321682	932 16 8	15	8433507	943 35 0	11			
8055167	905 51 6	82	8303145	930 31 4	12	8321767	932 17 6	15	8433699	943 36 9	11			
8055174	905 51 7	82	8303220	930 32 2	12	8321842	932 18 4	15	8433774	943 37 7	11			
8055181	905 51 8	82	8303305	930 33 0	12	8321927	932 19 2	15	8433859	943 38 5	11			
8055198	905 51 9	82	8303572	930 35 7	12									
8055204	905 52 0	82	8303732	930 37 3	12	8322054	932 20 5	15	8434061	943 40 6	11			
8055211	905 52 1	82	8303817	930 38 1	12	8322139	932 21 3	15	8434146	943 41 4	11			
8055228	905 52 2	82				8322214	932 22 1	15	8434221	943 42 2	11			
8055235	905 52 3	82	8304104	930 41 0	12				8434306	943 43 0	11			
8055242	905 52 4	82	8304371	930 43 7	12	8330202	933 02 0	112	8434498	943 44 9	11			
8055259	905 52 5	82	8304531	930 45 3	12				8434573	943 45 7	11			
8055266	905 52 6	82	8304616	930 46 1	12	8331797	933 17 9	10						
8055273	905 52 7	82	8304883	930 48 8	10	8331872	933 18 7	10	8943884	943 88 7	48			
8055297	905 52 9	82	8304968	930 49 6	10	8331957	933 19 5	10	8943891	943 89 5	48			
8055471	905 54 7	82												
8055488	905 54 8	84	8305095	930 50 9	10	8332084	933 20 8	10	8439097	943 90 9	49			
8055495	905 54 9	84	8305170	930 51 7	10	8332169	933 21 6	10	8439134	943 91 3	47			
8055617	905 56 1	84	8305255	930 52 5	10	8332244	933 22 4	11	8439172	943 91 7	49			
8055624	905 56 2	84	8305338	930 53 3	10	8332329	933 23 2	11	8439196	943 91 9	49			
8055730	905 57 3	84	8305415	930 54 1	10	8332756	933 27 5	10	8439202	943 92 0	49			
8055747	905 57 4	83	8305682	930 56 8	10				8439219	943 92 1	49			
			8305842	930 58 4	10	8333241	933 32 4	13	8439257	943 92 5	49			
8057727	905 77 2	83				8333296	933 32 9	13						
			8306054	930 60 5	10	8333333	933 33 3	13	8445159	944 51 5	16			
8179283	917 92 8	19	8306139	930 61 3	10	8333364	933 33 6	13						
8179290	917 92 9	19	8306481	930 64 8	10				8447832	944 78 3	13			
8179306	917 93 0	19	8306641	930 66 4	10	8366010	936 60 1	11						
8179313	917 93 1	19	8306801	930 68 0	10				8448471	944 84 7	13			
8179320	917 93 2	19	8306993	930 69 9	10	8373643	937 36 4	12	8448983	944 89 8	13			
8179337	917 93 3	19				8373728	937 37 2	12						
8179344	917 93 4	19	8307792	930 77 9	12				8451341	945 13 4	50			
8179351	917 93 5	19	8307877	930 78 7	12	8378907	937 89 0	11	8451631	945 16 3	50			
8179368	917 93 6	19	8307952	930 79 5	12				8451907	945 19 0	50			
8179375	917 93 7	19							8451983	945 19 8	50			
8179382	917 93 8	19	8308089	930 80 8	12	8382447	938 24 4	17						
			8308249	930 82 4	12	8382522	938 25 2	17						
			8308324	930 83 2	12	8382959	938 29 5	17	8452089	945 20 8	50			
			8308409	930 84 0	12									
8251798	925 17 9	11	8308591	930 85 9	12	8385004	938 50 0	12	8480716	948 07 1	11			
			8308676	930 86 7	12									
8275350	927 53 5	20	8308836	930 88 3	12	8391241	939 12 4	12	8484776	948 47 7	23			
8275374	927 53 7	20				8391678	939 16 7	13						
8275398	927 53 9	20				8391753	939 17 5	13	8486534	948 65 3	11			

Numeric directory

Structure of the GTIN: Country code **87** Manufacturer code **1367** Individual GTIN **5647589**

GTIN	Item no.	Page	GTIN	Item no.	Page	GTIN	Item no.	Page	GTIN	Item no.	Page
8495093	949 50 9	13	8550983	955 09 8	56	8642237	964 22 3	14	8732648	973 26 4	28
8495338	949 53 3	13	8550990	955 09 9	56	8642589	964 25 8	14	8732662	973 26 6	27
8495413	949 54 1	13				8642664	964 26 6	14	8732686	973 26 8	28
			8551010	955 10 1	56	8642749	964 27 4	14	8732723	973 27 2	29
8496489	949 64 8	13	8551195	955 11 9	93				8732747	973 27 4	29
8496564	949 65 6	13	8551201	955 12 0	93	8644187	964 41 8	14	8732785	973 27 8	29
8496649	949 66 4	13	8551218	955 12 1	93	8644262	964 42 6	14	8732808	973 28 0	29
8496717	949 67 1	13	8551225	955 12 2	93	8644347	964 43 4	14	8732846	973 28 4	29
8496755	949 67 5	13	8551270	955 12 7	93	8644422	964 44 2	14	8732907	973 29 0	29
8496809	949 68 0	13	8551287	955 12 8	93	8644507	964 45 0	14			
8496991	949 69 9	13	8551294	955 12 9	94	8644699	964 46 9	14	8734000	973 40 0	27
			8551300	955 13 0	94	8644774	964 47 7	14	8734017	973 40 1	27
									8734109	973 41 0	27
8497011	949 70 1	17							8734154	973 41 5	27
8497141	949 71 4	31	8566021	956 60 2	15	8651895	965 18 9	13	8734178	973 41 7	27
8497196	949 71 9	31	8566106	956 61 0	15				8734307	973 43 0	27
8497202	949 72 0	31	8566298	956 62 9	15	8661658	966 16 5	107			
8497288	949 72 8	17				8661726	966 17 2	107			
8497363	949 73 6	13	8567097	956 70 9	15	8661849	966 18 4	107	8738671	973 86 7	17
8497387	949 73 8	13	8567172	956 71 7	15	8661931	966 19 3	107	8738831	973 88 3	17
8497448	949 74 4	13	8567257	956 72 5	15						
8497523	949 75 2	17				8672050	967 20 5	17	8739128	973 91 2	10
			8570943	957 09 4	37	8672388	967 23 8	12			
						8672425	967 24 2	12	8777298	977 72 9	26
8550105	950 10 2	30				8672463	967 24 6	12	8777458	977 74 5	26
8501046	950 10 4	30	8571063	957 10 6	37						
8501060	950 10 6	30	8571100	957 11 0	37						
8501206	950 12 0	30	8571124	957 11 2	37	8673019	967 30 1	27	8804260	980 42 6	16
8501220	950 12 2	30	8571162	957 11 6	37	8673286	967 32 8	27			
8501268	950 12 6	30	8571186	957 11 8	37	8673446	967 34 4	28	8814535	981 45 3	96
			8571209	957 12 0	37	8673606	967 36 0	28	8814887	981 48 8	96
									8814962	981 49 6	96
8507956	950 79 5	40				8674597	967 45 9	28			
			8600039	960 00 3	47	8674672	967 46 7	26	8815099	981 50 9	96
8508007	950 80 0	40	8960041	960 04 6	48	8674757	967 47 5	26	8815174	981 51 7	96
8508038	950 80 3	39				8674832	967 48 3	26	8815334	981 53 3	96
8508045	950 80 4	40	8603023	960 30 2	48	8674917	967 49 1	26			
8508106	950 81 0	40									
8508205	950 82 0	40	8607830	960 78 3	11				8816201	981 62 0	99
8508250	950 82 5	40				8676782	967 67 8	26	8816218	981 62 1	99
8508281	950 82 8	40	8610007	961 00 0	113				8816225	981 62 2	99
8508335	950 83 3	40				8695264	969 52 6	17	8816232	981 62 3	98
8508687	950 86 8	39	8618157	961 81 5	18				8816249	981 62 4	98
8508762	950 87 6	39	8618232	961 82 3	18	8700258	970 02 5	48	8816256	981 62 5	98
8508847	950 88 4	39	8618317	961 83 1	18	8700333	970 03 3	48	8816263	981 62 6	98
8508922	950 89 2	39	8618584	961 85 8	18	8700418	970 04 1	48	8816270	981 62 7	98
			8961864	961 86 6	18	8700845	970 08 4	48	8816287	981 62 8	98
			8618744	961 87 4	18				8816393	981 63 9	99
8509301	950 93 0	41	8618829	961 88 2	18	8701217	970 12 2	52	8816508	981 65 0	137
8509325	950 93 2	41	8618898	961 88 9	18	8701651	970 16 5	52	8816515	981 65 1	138
8509806	950 98 0	39				8701828	970 18 2	53	8816522	981 65 2	138
8509998	950 99 9	39	8619208	961 92 0	18	8701842	970 18 4	53	8816539	981 65 3	137
			8619222	961 92 2	18				8816546	981 65 4	137
8510000	951 00 0	47				8702795	970 27 9	26	8816553	981 65 5	138
8510192	951 01 9	47							8816560	981 65 6	137
8510215	951 02 1	47	8624202	962 42 0	23				8816607	981 66 0	136
						8703082	970 30 8	26	8816614	981 66 1	136
8530367	953 03 6	18	8626909	962 69 0	48				8816621	981 66 2	136
8530374	953 03 7	18				8711162	971 11 6	26	8816638	981 66 3	136
			8628071	962 80 7	18				8816706	981 67 0	67
						8718888	971 88 8	23	8816713	981 67 1	67
8952275	954 90 0	102							8816720	981 67 2	67
8952282	954 90 2	102	8630524	963 05 2	107				8816737	981 67 3	67
8952299	954 90 4	102	8630609	963 06 0	107	8726968	972 69 6	17			
8952305	954 90 6	102	8630791	963 07 9	107						
8549086	954 90 8	102	8630876	963 08 7	107	8727118	972 71 1	16			
8549109	954 91 0	102				8727132	972 71 3	16	8818601	981 86 0	119
8549123	954 91 2	102	8631163	963 11 6	106	8727156	972 71 5	16	8818618	981 86 1	119
8549147	954 91 4	102	8631248	963 12 4	106	8727170	972 71 7	16	8818625	981 86 2	119
8549161	954 91 6	102	8631675	963 16 7	107	8727194	972 71 9	16	8818632	981 86 3	119
8549222	954 92 2	92				8727217	972 72 1	16	8818649	981 86 4	119
8549260	954 92 6	104	8632559	963 25 5	112				8818656	981 86 5	119
8549277	954 92 7	104	8632627	963 26 2	112	8729280	972 92 8	16	8818663	981 86 6	119
8549284	954 92 8	104	8632641	963 26 4	112	8729440	972 94 4	16	8818861	981 88 6	119
8549291	954 92 9	104									
8549307	954 93 0	103	8633006	963 30 0	108	8730668	973 06 6	13	8819004	981 90 0	119
8549345	954 93 4	103	8633198	963 31 9	108	8730743	973 07 4	26	8819028	981 90 2	118
8549383	954 93 8	103	8633273	963 32 7	108	8730828	973 08 2	26	8819103	981 91 0	118
8549420	954 94 2	103	8633358	963 33 5	108	8730903	973 09 0	26	8819141	981 91 4	119
8549468	954 94 6	103							8819172	981 91 7	119
			8634072	963 40 7	106	8731030	973 10 3	26	8819189	981 91 8	119
8550013	955 00 1	43	8634157	963 41 5	106	8731702	973 17 0	13	8819240	981 92 4	118
8550280	955 02 8	43	8634232	963 42 3	106				8819370	981 93 7	118
8550365	955 03 6	43	8634317	963 43 1	106	8732341	973 23 4	26	8819448	981 94 4	118
8550440	955 04 4	43	8634584	963 45 8	106	8732402	973 24 0	28	8819493	981 94 9	122
8550525	955 05 2	43				8732426	973 24 2	28	8819509	981 95 0	118
8550549	955 05 4	43	8635031	963 50 3	108	8732440	973 24 4	28	8819554	981 95 5	118
8550938	955 09 3	54	8635116	963 51 1	108	8732501	973 25 0	28	8819585	981 95 8	118
8550945	955 09 4	55	8635468	963 54 6	108	8732532	973 25 3	28	8819608	981 96 0	118
8550952	955 09 5	54				8732549	973 25 4	28	8819851	981 98 5	122
8550969	955 09 6	55	8642077	964 20 7	14	8732556	973 25 5	28	8819868	981 98 6	122
8550976	955 09 7	54	8642152	964 21 5	14	8732600	973 26 0	28	8819875	981 98 7	122

GTIN	Item no.	Page	GTIN	Item no.	Page	GTIN	Item no.	Page	GTIN	Item no.	Page	GTIN	Item no.	Page
8819882	981 98 8	122	8864738	986 47 3	12	1914035	991 40 3	97	8981611	998 16 1	88			
8819899	981 98 9	122							8981635	998 16 2	88			
8819974	981 99 7	121	8865292	986 52 9	12	8915058	991 50 5	62	8981635	998 16 3	89			
8819981	981 99 8	121	8865889	986 58 8	10	8915072	991 50 7	62	8981642	998 16 4	89			
8819998	981 99 9	121				8915300	991 53 0	62	8981659	998 16 5	89			
			8866091	986 60 9	10				8981666	998 16 6	89			
8820000	982 00 0	121	8866411	986 64 1	10	8922797	992 27 9	75	8981673	998 16 7	89			
8820017	982 00 1	121	8866763	986 67 6	10				8981680	998 16 8	89			
8820024	982 00 2	121	8866848	986 68 4	12	1923204	992 32 0	13	8981697	998 16 9	89			
8820055	982 00 5	119				1923396	992 33 9	13	8981703	998 17 0	89			
8820079	982 00 7	119	8867210	986 72 1	12	1923471	992 34 7	13	8981710	998 17 1	89			
8820130	982 01 3	121	8867647	986 76 4	10	8923558	992 35 5	13						
			8867807	986 78 0	10	8923633	992 36 3	13	8982630	998 26 3	46			
8830023	983 00 2	13				8923718	992 37 1	13	8982647	998 26 4	46			
8830108	983 01 0	13	8868019	986 80 1	10				8998273	998 27 1	46			
			8868286	986 82 8	12	8924197	992 41 9	13	8982982	998 29 8	46			
8831846	983 18 4	15	8868521	986 85 2	10	8924906	992 49 0	13						
			8868606	986 86 0	12	8924944	992 49 4	13	8983002	998 30 0	46			
			8868873	986 88 7	12									
8832058	983 20 5	15				8927501	992 75 0	17	8987055	998 70 5	46			
8832218	983 22 1	15				8927518	992 75 1	17	8987062	998 70 6	46			
8832485	983 24 8	25	8869245	986 92 4	12				8987109	998 71 0	46			
8832560	983 25 6	15	7886991	986 99 1	10				8987604	998 76 0	46			
8832720	983 27 2	15				8993483	993 48 9	23	8987628	998 76 2	46			
8832805	983 28 0	25	8870463	987 04 6	10				8987642	998 76 4	46			
8832997	983 29 9	15	8870548	987 05 4	11	8935858	993 58 5	23	8987666	998 76 6	46			
			8870708	987 07 0	11									
			8870976	987 09 7	11	8936145	993 61 4	23						
8833017	983 30 1	25				8936572	993 65 7	23	8990796	999 07 9	148			
8833284	983 32 8	15				8936817	993 68 1	23	8990802	999 08 0	148			
8833444	983 34 4	15	8871699	987 16 9	10				8990819	999 08 1	148			
8833604	983 36 0	15							8990826	999 08 2	148			
8833871	983 38 7	15	8872061	987 20 6	10	8944027	994 40 2	49	8990833	999 08 3	148			
8833956	983 39 5	25				1944131	994 41 3	19	8990840	999 08 4	148			
			8874416	987 44 1	11	1944148	994 41 4	19	8990857	999 08 5	148			
8834083	983 40 8	15	8874768	987 47 6	11	1944155	994 41 5	19						
8834243	983 42 4	15				8944188	994 41 8	13						
8834403	983 44 0	15	8875130	987 51 3	11				8991007	999 10 0	46			
8834670	983 46 7	15				1945022	994 50 2	23	8991199	999 11 9	46			
8834830	983 48 3	15	8890409	989 04 0	17	1945107	994 51 0	23						
			8890423	989 04 2	17	1945886	994 58 8	23	8993896	999 38 9	46			
8835042	983 50 4	15	8890508	989 05 0	17	1945961	994 59 6	23	8993902	999 39 0	46			
8835127	983 51 2	24	8890522	989 05 2	17				8993940	999 39 4	49			
8835202	983 52 0	15	8890546	989 05 4	17	8946007	994 60 0	118	8993971	999 39 7	46			
8835479	983 54 7	15				8946021	994 60 2	118						
8983552	983 55 5	24	8909002	990 90 0	97	8946113	994 61 1	118	8994008	999 40 0	49			
8835639	983 56 3	15	8909019	990 90 1	97	8946281	994 62 8	118	8994015	999 40 1	49			
8835714	983 57 1	24	8909033	990 90 3	97	8946298	994 62 9	118	8994022	999 40 2	49			
8835981	983 59 8	15	8909057	990 90 5	97				8994039	999 40 3	49			
			8909064	990 90 6	97	8951261	995 12 6	26	8994060	999 40 6	49			
8836001	983 60 0	24	8909071	990 90 7	97				8994077	999 40 7	49			
8836193	983 61 9	15	8909088	990 90 8	97	1952143	995 21 4	97	8994084	999 40 8	49			
8836278	983 62 7	24	8909095	990 90 9	97	8952152	995 21 5	97	8994114	999 41 1	49			
8836353	983 63 5	15	8909101	990 91 0	97	1952167	995 21 6	97						
8836513	983 65 1	15				8952190	995 21 9	97						
8836780	983 67 8	24	8910022	991 00 2	96	8952206	995 22 0	97						
8836865	983 68 6	15	8910107	991 01 0	96	1952273	995 22 7	101						
8836940	983 69 4	24	8910299	991 02 9	96	1952280	995 22 8	101						
			8910374	991 03 7	96	1952297	995 22 9	101						
8837077	983 70 7	15	8910459	991 04 5	96	1952303	995 23 0	101						
8837152	983 71 5	24	8910534	991 05 3	96	1952310	995 23 1	101						
8837237	983 72 3	15				1952327	995 23 2	101						
8837664	983 76 6	24	8911098	991 10 9	133	1952334	995 23 3	101						
8837824	983 78 2	24	8911104	991 11 0	134	1952341	995 23 4	101						
			8911111	991 11 1	135									
8838111	983 81 1	24	8911173	991 11 7	133	8958983	995 89 8	11						
8838463	983 84 6	24	8911180	991 11 8	134									
8838890	983 88 9	24	8911197	991 11 9	135	8970096	997 00 9	10						
			8911357	991 13 5	129									
8839187	983 91 8	24	8911364	991 13 6	129	8976073	997 60 7	26						
8839347	983 93 4	24	8911388	991 13 8	130	8976233	997 62 3	28						
8839774	983 97 7	24	8911395	991 13 9	131	8976318	997 63 1	28						
			8911418	991 14 1	130	8976745	997 67 4	28						
8840138	984 01 3	24	8911425	991 14 2	131	8976820	997 68 2	28						
8840480	984 04 8	24	8911562	991 15 6	130									
8840640	984 06 4	24	8911579	991 15 7	130	8979302	997 93 0	23						
8840800	984 08 0	24	8911685	991 16 8	134	8979579	997 95 7	26						
			8911760	991 17 6	134									
8841012	984 10 1	24	8911777	991 17 7	133	8981505	998 15 0	86						
			8911784	991 17 8	134	8981512	998 15 1	86						
8860785	986 07 8	12	8911791	991 17 9	134	8981529	998 15 2	86						
			8911814	991 18 1	135	8981536	998 15 3	86						
						8981543	998 15 4	86						
8862383	986 23 8	12				8981550	998 15 5	86						
8862543	986 25 4	12	8912040	991 20 4	117	8981567	998 15 6	87						
8862932	986 29 3	12	8912057	991 20 5	117	8981574	998 15 7	87						
8862970	986 29 7	12	8912071	991 20 7	117	8981581	998 15 8	87						
			8912132	991 21 3	117	8981598	998 15 9	87						
8864493	986 42 2	12	8912156	991 21 5	132	8981604	998 16 0	88						
8864493	986 44 9	12	8912163	991 21 6	132									

Type listing

Structure of the GTIN: Country code **87** Manufacturer code **1367** Individual GTIN **5647589**

Type	Dimensions/colour/div.	GTIN	Item no.	Page	Type	Dimensions/colour/div.	GTIN	Item no.	Page
OZ077 9X132	Black9	8045908	904 59 0	61	FP 18		4 8508038	950 80 3	39
OZ077 9X180	Black9	8045915	904 59 1	61					
OZ077 9X260	Black9	8045922	904 59 2	61	FP 4/9x14		4 8508847	950 88 4	39
OZ077 9X360	Black9	8045939	904 59 3	61	FP 4/9x18		4 8508922	950 89 2	39
					FP 4/9x22		4 8509806	950 98 0	39
B058 3,0x30		3 8179283	917 92 8	19	FP 4/9x27		4 8509998	950 99 9	39
B058 3,0x50		3 8179290	917 92 9	19	FP 4/9x35		4 8508687	950 86 8	39
B058 3,0x50		3 8179306	917 93 0	19	FP 4/9x40		4 8508762	950 87 6	39
B058 3,0x60		3 8179313	917 93 1	19					
B058 3,0x70		3 8179320	917 93 2	19	FPG 4x18		4 8509301	950 93 0	41
B058 3,4x100		3,4 8179382	917 93 8	19	FPG 4x18		4 8509325	950 93 2	41
B058 3,4x50		3,4 8179337	917 93 3	19					
B058 3,4x60		3,4 8179344	917 93 4	19	GE001 UNI68	Red	8981505	998 15 0	86
B058 3,4x70		3,4 8179351	917 93 5	19	GE001 UNI82	Red	8981512	998 15 1	86
B058 3,4x80		3,4 8179368	917 93 6	19	GE002 NRS68	Green	8981529	998 15 2	86
B058 3,4x90		3,4 8179375	917 93 7	19	GE002 NRS82	Green	8981536	998 15 3	86
					GE003 M68	White	8981550	998 15 5	86
B059 3,4x40		3,4 8276661	927 66 6	19	GE003 M82	White	8981543	998 15 4	86
B059 3,4x50		3,4 8276678	927 66 7	19	GE004	Black	8981567	998 15 6	87
B059 3,4x70		3,4 8276692	927 66 9	19	GE005		8981574	998 15 7	87
B059 3,4x80		3,4 8276715	927 67 1	19	GE006		8981581	998 15 8	87
B059 3x40		3 8276708	927 67 0	19	GE007		8981598	998 15 9	87
B059 3x50		3 8276722	927 67 2	19	GE008		8981604	998 16 0	88
B059 3x60		3 8276746	927 67 4	19	GE009		8981611	998 16 1	88
B059 3x70		3 8276760	927 67 6	19					
					GE010		8981635	998 16 2	88
DKS 25-34x3,0x40	Natural 25x34	8549260	954 92 6	104	GE011 115	Red	8981635	998 16 3	89
DKS 25-34x3,50x50	Natural 25x34	8549277	954 92 7	104	GE011 125	Red	8981642	998 16 4	89
DKS 25-34x3,50x60	Natural 25x34	8549284	954 92 8	104	GE011 150	Red	8981659	998 16 5	89
DKS 25-34x3,50x70	Natural 25x34	8549291	954 92 9	104	GE012 115	Green	8981666	998 16 6	89
					GE012 125	Green	8981673	998 16 7	89
EM001 0,5-2,5x3	Grey	8043324	904 33 2	78	GE012 150	Green	8981680	998 16 8	89
EM002 0,5-2,5x5	Grey	8043331	904 33 3	78	GE013 115	White	8981697	998 16 9	89
EM003 4x12 pol	White	8043362	904 33 6	76	GE013 125	White	8981703	998 17 0	89
EM004 6x12 pol	White	8043379	904 33 7	76	GE013 150	White	8981710	998 17 1	89
EM005 10x12 pol	White	8043386	904 33 8	76					
EM006 16x12 pol	White	8043393	904 33 9	76	KC014 2x40		2 8672388	967 23 8	12
EM008 2,5x12 pol	sorted	8043409	904 34 0	77	KC014 2x50		2 8672425	967 24 2	12
EM008 2,5x12 pol	Black	8043416	904 34 1	77	KC014 2x60		2 8672463	967 24 6	12
EM009 10	Grey	8043430	904 34 4	74					
					KG001 3,75x22		3,75 8628071	962 80 7	18
EM010 7	Grey	8043430	904 34 3	74	KG001 3,75x27		3,75 8618157	961 81 5	18
EM011 12	Grey	8043454	904 34 5	75	KG001 3,75x32		3,75 8618232	961 82 3	18
EM014		8051060	905 10 6	149	KG001 3,75x37		3,75 8618317	961 83 1	18
EM015		8051053	905 10 5	146	KG001 3,75x42		3,75 8618584	961 85 8	18
EM018 13-15		8051114	905 11 1	145	KG001 3,75x47		3,75 8961864	961 86 6	18
EM018 16-18		8051121	905 11 2	145	KG001 3,75x54		3,75 8618744	961 87 4	18
EM018 19-22		8051138	905 11 3	145	KG001 3,75x62		3,75 8618829	961 88 2	18
EM018 24-28		8051145	905 11 4	145	KG001 3,75x72		3,75 8618898	961 88 9	18
EM018 30-35		8051152	905 11 5	145	KG001 3,75x82		3,75 8619208	961 92 0	18
EM018 8-11		8051107	905 11 0	145	KG001 3,75x97		3,75 8619222	961 92 2	18
EM019 3/8-1 1/2 2.5x16	2,5-16	8051022	905 10 2	144	KG003 2,5x25		2,5 8530374	953 03 7	18
EM019 8-22 2.5x10	2,5-10	8051015	905 10 1	144	KG003 2,5x30		2,5 8530367	953 03 6	18
EM019 3/8-4 2.5x16	2,5-16	8051039	905 10 3	144					
					KG010 2x12		2 8044598	904 45 9	21
EM020 16	Grey	8922797	992 27 9	75	KG010 2x16		2 8044604	904 46 0	21
EM021 7-25		8051077	905 10 7	147	KG010 2x18		2 8044611	904 46 1	21
EM022 I-1 0,2-0,5	Grey	8042501	904 25 0	80	KG010 2x23		2 8044628	904 46 2	21
EM022 I-2 0,6-1,0	Grey	8042518	904 25 1	80	KG010 2x30		2 8044635	904 46 3	21
EM022 I-3 1,25-2,0	Grey	8042525	904 25 2	80	KG010 2x40		2 8044642	904 46 4	21
EM022 I-4 2,25-3,0	Grey	8042532	904 25 3	80	KG010 2x50		2 8044659	904 46 5	21
EM022 I-5 3,25-5,0	Grey	8042549	904 25 4	80	KG010 2x60		2 8044666	904 46 6	21
EM022 T-1 0,2-0,5	Grey	8042600	904 26 0	80	KG011 2x12		2 8044673	904 46 7	21
EM022 T-2 0,6-1,0	Grey	8042617	904 26 1	80	KG011 2x16		2 8044680	904 46 8	21
EM022 T-3 1,25-2,0	Grey	8042624	904 26 2	80	KG011 2x18		2 8044697	904 46 9	21
EM022 T-4 2,25-3,0	Grey	8042631	904 26 3	80	KG011 2x23		2 8044703	904 47 0	21
EM022 T-5 3,25-5,0	Grey	8042648	904 26 4	80	KG011 2x30		2 8044710	904 47 1	21
EM023 1,0	1000	8990796	999 07 9	148	KG011 2x40		2 8044727	904 47 2	21
EM023 1,5	1500	8990802	999 08 0	148	KG011 2x50		2 8044734	904 47 3	21
EM023 2,0	2000	8990819	999 08 1	148	KG011 2x60		2 8044741	904 47 4	21
EM024 1,5	1500	8990840	999 08 4	148	KG012 2x12		2 8044758	904 47 5	22
EM024 2,0	2000	8990857	999 08 5	148	KG012 2x16		2 8044765	904 47 6	22
EM025 1,5	1500	8990826	999 08 2	148	KG012 2x18		2 8044772	904 47 7	22
EM025 2,0	2000	8990833	999 08 3	148	KG012 2x23		2 8044789	904 47 8	22
EM027 15x10	Black15	8420002	942 00 0	65	KG012 2x30		2 8044796	904 47 9	22
EM027 15x10	Red15	8420019	942 00 1	65	KG012 2x40		2 8044802	904 48 0	22
EM027 15x10	Blue15	8420026	942 00 2	65	KG012 2x50		2 8044819	904 48 1	22
EM027 15x10	Brown15	8420035	942 00 3	65	KG012 2x60		2 8044826	904 48 2	22
EM027 15x10	Yellow green15	8420042	942 00 4	65	KG013 2x12		2 8044833	904 48 3	22
EM028 15x10W	Black15	8420059	942 00 5	65	KG013 2x16		2 8044840	904 48 4	22
EM029 19x5	Black15	8420066	942 00 6	66	KG013 2x18		2 8044857	904 48 5	22
					KG013 2x23		2 8044864	904 48 6	22
EM030 45x25	Black45	8420103	942 00 7	66	KG013 2x30		2 8044871	904 48 7	22
EM031 12x12	White12	8420080	942 00 8	66	KG013 2x40		2 8044888	904 48 8	22
					KG013 2x50		2 8044895	904 48 9	22
ESCP 15,16x5x28	Grey5	8631163	963 11 6	106					
ESCP 18,19x5x28	Grey5	8631248	963 12 4	106	KKB 10	Grey10	8911777	991 17 7	133

Type	Dimensions/colour/div.	GTIN	Item no.	Page	Type	Dimensions/colour/div.	GTIN	Item no.	Page
KKB 10F	Stone grey 10	8911791	991 17 9	134	KS002 4,5x100	4,5 8831846	983 18 4	15	
KKB 10F6x55	Stone grey 10	8911814	991 18 1	135	KS002 4,5x30	4,5 8833871	983 38 7	15	
KKB 10x6x55	Grey 10	8911784	991 17 8	134	KS002 4,5x40	4,5 8833604	983 36 0	15	
KKB 16	Grey 16	8911173	991 11 7	133	KS002 4,5x50	4,5 8321767	932 17 6	15	
KKB 16F	Stone grey 16	8911180	991 11 8	134	KS002 4,5x50	4,5 8833444	983 34 4	15	
KKB 16F6x55	Stone grey 16	8911197	991 11 9	135	KS002 4,5x55	4,5 8833284	983 32 8	15	
KKB 16x6x55	Grey 16	8911685	991 16 8	134	KS002 4,5x60	4,5 8321842	932 18 4	15	
KKB 8	Grey 8	8911098	991 10 9	133	KS002 4,5x60	4,5 8832997	983 29 9	15	
KKB 8F	Stone grey 8	8911104	991 11 0	134	KS002 4,5x65	4,5 8832720	983 27 2	15	
KKB 8F6x55	Stone grey 8	8911111	991 11 1	135	KS002 4,5x70	4,5 8321927	932 19 2	15	
KKB 8x6x55	Grey 8	8911760	991 17 6	134	KS002 4,5x70	4,5 8832560	983 25 6	15	
					KS002 4,5x80	4,5 8322054	932 20 5	15	
KKM 15	15	8912156	991 21 5	132	KS002 4,5x80	4,5 8832218	983 22 1	15	
KKM 30	30	8912163	991 21 6	132	KS002 4,5x90	4,5 8322139	932 21 3	15	
					KS002 4,5x90	4,5 8832058	983 20 5	15	
KKS 15	Grey 15	8911364	991 13 6	129	KS004 1,5x25	1,5 8970096	997 00 9	10	
KKS 15F	Stone grey 15	8911562	991 15 6	130	KS004 2,5x25	2,5 8305415	930 54 1	10	
KKS 15F6x55	Stone grey 15	8911395	991 13 9	131	KS004 2,5x25	2,5 8298823	929 88 2	10	
KKS 15x6x55	Grey 15	8911388	991 13 8	130	KS004 2,5x30	2,5 8298908	929 89 0	10	
KKS 30	Grey 30	8911357	991 13 5	129	KS004 2,5x30	2,5 8305682	930 56 8	10	
KKS 30F	Stone grey 30	8911579	991 15 7	130	KS004 2,5x35	2,5 8299035	929 90 3	10	
KKS 30F6x55	Stone grey 30	8911425	991 14 2	131	KS004 2,5x40	2,5 8305842	930 58 4	10	
KKS 30x6x55	Grey 30	8911418	991 14 1	130	KS004 2,5x40	2,5 8299110	929 91 1	10	
					KS004 2,5x40	2,5 8870463	987 04 6	10	
KLS 27	Natural	8952275	954 90 0	102	KS004 2,5x50	2,5 8306054	930 60 5	10	
KLS 27x2,0x40	Natural	8952282	954 90 2	102	KS004 2,5x50	2,5 8299462	929 94 6	10	
KLS 27x2,0x50	Natural	8952299	954 90 4	102	KS004 2,5x50	2,5 7886991	986 99 1	10	
KLS 34	Natural	8952305	954 90 6	102	KS004 2x16	2 8304883	930 48 8	10	
KLS 34x2,0x50	Natural	8549086	954 90 8	102	KS004 2x16	2 8298151	929 81 5	10	
KLS 34x2,0x60	Natural	8549109	954 91 0	102	KS004 2x20	2 8304968	930 49 6	10	
KLS 34x3,3x40	Natural	8549123	954 91 2	102	KS004 2x20	2 8298236	929 82 3	10	
KLS 34x3,3x50	Natural	8549147	954 91 4	102	KS004 2x23	2 8302506	930 25 0	10	
KLS 34x3,3x60	Natural	8549161	954 91 6	102	KS004 2x25	2 8305095	930 50 9	10	
					KS004 2x25	2 8298311	929 83 1	10	
KPA 100x8x70	White	8320081	932 00 8	109	KS004 2x30	2 8305170	930 51 7	10	
KPA 100x8x70		8320029	932 00 2	109	KS004 2x30	2 8298588	929 85 8	10	
KPA 10x100	Grey 10	8451631	945 16 3	50	KS004 2x30	2 8872061	987 20 6	10	
KPA 10x100	Natural 10	8439172	943 91 7	49	KS004 2x35	2 8305255	930 52 5	10	
KPA 10x120	Grey 10	8451907	945 19 0	50	KS004 2x35	2 8298663	929 86 6	10	
KPA 10x120	Natural 10	8439257	943 92 5	49	KS004 2x40	2 8305338	930 53 3	10	
KPA 10x140	Grey 10	8451983	945 19 8	50	KS004 2x40	2 8298748	929 87 4	10	
KPA 10x140	Natural 10	8439202	943 92 0	49	KS004 2x40	2 8871699	987 16 9	10	
KPA 10x160	Grey 10	8452089	945 20 8	50	KS004 3,4x40	3,4 8332756	933 27 5	10	
KPA 10x160	Natural 10	8439219	943 92 1	49	KS004 3,4x50	3,4 8866763	986 67 6	10	
KPA 30x102	Grey	8320302	932 03 0	110	KS004 3,4x50	3,4 8331872	933 18 7	10	
KPA 70x8x70		8320005	932 00 0	109	KS004 3,4x60	3,4 8866411	986 64 1	10	
KPA 80x8x70	White	8320074	932 00 7	109	KS004 3,4x60	3,4 8331957	933 19 5	10	
KPA 80x8x70		8320012	932 00 1	109	KS004 3,4x70	3,4 8866091	986 60 9	10	
KPA 8x100	Grey 8	8320289	932 02 8	109	KS004 3,4x70	3,4 8332084	933 20 8	10	
KPA 8x120	Natural 8	8439097	943 90 9	49	KS004 3,4x80	3,4 8865889	986 58 8	10	
KPA 8x120	Grey 8	8451341	945 13 4	50	KS004 3,4x80	3,4 8332169	933 21 6	10	
KPA 8x140	Natural 8	8439196	943 91 9	49	KS004 3x30	3 8306481	930 64 8	10	
KPA B g	Grey	8320241	932 02 4	110	KS004 3x30	3 8299707	929 97 0	10	
KPA B w	White	8320265	932 02 6	110	KS004 3x40	3 8306641	930 66 4	10	
					KS004 3x40	3 8299974	929 99 7	10	
KS002 2,7x35	2,7	8837237	983 72 3	15	KS004 3x40	3 8868521	986 85 2	10	
KS002 2,7x35	2,7	8319153	931 91 5	15	KS004 3x50	3 8306801	930 68 0	10	
KS002 2,7x40	2,7	8319238	931 92 3	15	KS004 3x50	3 8300151	930 01 5	10	
KS002 2,7x40	2,7	8837077	983 70 7	15	KS004 3x50	3 8868019	986 80 1	10	
KS002 2,7x50	2,7	8319313	931 93 1	15	KS004 3x60	3 8306993	930 69 9	10	
KS002 2,7x50	2,7	8836865	983 68 6	15	KS004 3x60	3 8300236	930 02 3	10	
KS002 2,7x60	2,7	8319580	931 95 8	15	KS004 3x60	3 8867807	986 78 0	10	
KS002 2,7x60	2,7	8836513	983 65 1	15	KS004 3x70	3 8867647	986 76 4	10	
KS002 2,7x70	2,7	8319665	931 96 6	15	KS004 3x70	3 8331797	933 17 9	10	
KS002 2,7x70	2,7	8836353	983 63 5	15	KS004 4,2x100	4,2 8870548	987 05 4	11	
KS002 3,5x30	3,5	8319740	931 97 4	15	KS004 4,2x100	4,2 8332329	933 23 2	11	
KS002 3,5x30	3,5	8836193	983 61 9	15	KS004 4,2x70	4,2 8378907	937 89 0	11	
KS002 3,5x35	3,5	8432036	943 20 3	15	KS004 4,2x80	4,2 8870976	987 09 7	11	
KS002 3,5x35	3,5	8835981	983 59 8	15	KS004 4,2x90	4,2 8870708	987 07 0	11	
KS002 3,5x40	3,5	8319900	931 99 0	15	KS004 4,2x90	4,2 8332244	933 22 4	11	
KS002 3,5x40	3,5	8835639	983 56 3	15	KS006 2,5x16	2,5 8373643	937 36 4	12	
KS002 3,5x45	3,5	8320883	932 08 8	15	KS006 2,5x20	2,5 8373728	937 37 2	12	
KS002 3,5x45	3,5	8835479	983 54 7	15	KS006 2,5x25	2,5 8308324	930 83 2	12	
KS002 3,5x50	3,5	8320968	932 09 6	15	KS006 2,5x25	2,5 8303220	930 32 2	12	
KS002 3,5x50	3,5	8835202	983 52 0	15	KS006 2,5x30	2,5 8308409	930 84 0	12	
KS002 3,5x55	3,5	8321101	932 11 0	15	KS006 2,5x30	2,5 8303305	930 33 0	12	
KS002 3,5x55	3,5	8835042	983 50 4	15	KS006 2,5x30	2,5 8867210	986 72 1	12	
KS002 3,5x60	3,5	8321170	932 11 7	15	KS006 2,5x35	2,5 8308591	930 85 9	12	
KS002 3,5x60	3,5	8834830	983 48 3	15	KS006 2,5x40	2,5 8308676	930 86 7	12	
KS002 3,5x65	3,5	8332121	932 12 5	15	KS006 2,5x40	2,5 8303572	930 35 7	12	
KS002 3,5x65	3,5	8834670	983 46 7	15	KS006 2,5x40	2,5 8866848	986 68 4	12	
KS002 3,5x70	3,5	8321330	932 13 3	15	KS006 2,5x50	2,5 8308836	930 88 3	12	
KS002 3,5x70	3,5	8834403	983 44 0	15	KS006 2,5x50	2,5 8303732	930 37 3	12	
KS002 3,5x75	3,5	8834243	983 42 4	15	KS006 2x16	2 8307792	930 77 9	12	
KS002 3,5x80	3,5	8321682	932 16 8	15	KS006 2x16	2 8302698	930 26 9	12	
KS002 3,5x80	3,5	8834083	983 40 8	15	KS006 2x20	2 8307877	930 78 7	12	
KS002 4,5x100	4,5	8322214	932 22 1	15	KS006 2x20	2 8302773	930 27 7	12	

Type listing

Structure of the GTIN: Country code **87** Manufacturer code **1367** Individual GTIN **5647589**

Type	Dimensions/colour/div.	GTIN	Item no.	Page	Type	Dimensions/colour/div.	GTIN	Item no.	Page
KS006 2x20		2 8869245	986 92 4	12	KS111 3,4x55	3,4 8923633	992 36 3	13	
KS006 2x25		2 8307952	930 79 5	12	KS111 3,4x60	3,4 8830108	983 01 0	13	
KS006 2x25		2 8302858	930 28 5	12	KS111 3,4x60	3,4 8497387	949 73 8	13	
KS006 2x25		2 8868873	986 88 7	12	KS111 3,4x65	3,4 8923718	992 37 1	13	
KS006 2x30		2 8308089	930 80 8	12	KS111 3,4x70	3,4 8395119	939 51 1	13	
KS006 2x30		2 8302933	930 29 3	12	KS111 3,4x80	3,4 8730668	973 06 6	13	
KS006 2x30		2 8868606	986 86 0	12	KS111 3,5x40	3,5 8496809	949 68 0	13	
KS006 2x40		2 8308249	930 82 4	12	KS111 3,5x50	3,5 8496991	949 69 9	13	
KS006 2x40		2 8303145	930 31 4	12	KS111 3,5x60	3,5 8497363	949 73 6	13	
KS006 2x40		2 8868286	986 82 8	12	KS111 3,5x70	3,5 8497448	949 74 4	13	
KS006 3,4x50		3,4 8862932	986 29 3	12	KS111 3x25	3 8391678	939 16 7	13	
KS006 3,4x60		3,4 8862970	986 29 7	12	KS111 3x30	3 8333296	933 32 9	13	
KS006 3,4x70		3,4 8862543	986 25 4	12	KS111 3x30	3 8391753	939 17 5	13	
KS006 3,4x80		3,4 8862383	986 23 8	12	KS111 3x35	3 8391838	939 18 3	13	
KS006 3x30		3 8304104	930 41 0	12	KS111 3x40	3 8333333	933 33 3	13	
KS006 3x30		3 8309123	930 91 2	12	KS111 3x40	3 8391913	939 19 1	13	
KS006 3x30		3 8865292	986 52 9	12	KS111 3x40	3 8496489	949 64 8	13	
KS006 3x40		3 8304371	930 43 7	12	KS111 3x45	3 8392040	939 20 4	13	
KS006 3x40		3 8309390	930 93 9	12	KS111 3x50	3 8333364	933 33 6	13	
KS006 3x40		3 8864738	986 47 3	12	KS111 3x50	3 8392125	939 21 2	13	
KS006 3x50		3 8304531	930 45 3	12	KS111 3x50	3 8496564	949 65 6	13	
KS006 3x50		3 8309550	930 95 5	12	KS111 3x60	3 8392200	939 22 0	13	
KS006 3x50		3 8864493	986 44 9	12	KS111 3x60	3 8496649	949 66 4	13	
KS006 3x60		3 8304616	930 46 1	12	KS111 3x65	3 8392392	939 23 9	13	
KS006 3x60		3 8309635	930 96 3	12	KS111 3x70	3 8392477	939 24 7	13	
KS006 3x60		3 8864493	986 42 2	12	KS111 3x70	3 8651895	965 18 9	13	
KS006 3x70		3 8385004	938 50 0	12	KS111 3x75	3 8392552	939 25 5	13	
KS006 4,2x90		4,2 8860785	986 07 8	12	KS111 4,2x100	4,2 8731702	973 17 0	13	
KS008 2,5x16		2,5 8875130	987 51 3	11	KS111 4,2x60	4,2 1923204	992 32 0	13	
KS008 2,5x25		2,5 8403609	940 36 0	11	KS111 4,2x70	4,2 1923396	992 33 9	13	
KS008 2,5x30		2,5 8874768	987 47 6	11	KS111 4,2x80	4,2 1923471	992 34 7	13	
KS008 2,5x40		2,5 8874416	987 44 1	11	KS111 4,2x90	4,2 8924197	992 41 9	13	
					KS112 3,5x100	3,5 8727217	972 72 1	16	
KS076 1,5x20		1,5 8726968	972 69 6	17	KS112 3,5x20	3,5 8804260	980 42 6	16	
KS076 1,5x25		1,5 8382447	938 24 4	17	KS112 3,5x25	3,5 8729280	972 92 8	16	
KS076 1,5x30		1,5 8382522	938 25 2	17	KS112 3,5x30	3,5 8445159	944 51 5	16	
KS076 2x30		2 8408383	940 83 8	17	KS112 3,5x35	3,5 8729440	972 94 4	16	
KS076 2x35		2 8695264	969 52 6	17	KS112 3,5x40	3,5 8727118	972 71 1	16	
KS076 2x40		2 8382959	938 29 5	17	KS112 3,5x50	3,5 8727132	972 71 3	16	
					KS112 3,5x60	3,5 8727156	972 71 5	16	
KS084 2,5x60		2,5 8306139	930 61 3	10	KS112 3,5x70	3,5 8727170	972 71 7	16	
KS084 2,5x60		2,5 8299547	929 95 4	10	KS112 3,5x80	3,5 8727194	972 71 9	16	
KS084 2x60		2 8739128	973 91 2	10					
KS085 1,5x35		1,5 8497011	949 70 1	17	KS123 3,4x100	3,4 8366010	936 60 1	11	
KS085 1,5x40		1,5 8497523	949 75 2	17	KS123 3,4x90	3,4 8434573	943 45 7	11	
KS085 1,5x45		1,5 8497288	949 72 8	17	KS125 2,5x60	2,5 8303817	930 38 1	12	
					KS125 2,5x70	2,5 8391241	939 12 4	12	
KS110 2,5x25		2,5 8433187	943 31 8	11					
KS110 2,5x30		2,5 8251798	925 17 9	11	KS132 2x40	2 8283379	928 33 7	19	
KS110 2x20		2 8958983	995 89 8	11	KS132 3x30	3 8283751	928 37 5	19	
KS110 2x25		2 8607830	960 78 3	11	KS132 3x50	3 8283850	928 38 5	19	
KS110 2x30		2 8480716	948 07 1	11	KS132 3x60	3 8283935	928 39 3	19	
KS110 3,4x25		3,4 8433507	943 35 0	11	KS132 4x100	4 1944155	994 41 5	19	
KS110 3,4x30		3,4 8432975	943 29 7	11	KS132 4x50	4 8284208	928 42 0	19	
KS110 3,4x40		3,4 8433699	943 36 9	11	KS132 4x50	4 8284222	928 42 2	19	
KS110 3,4x45		3,4 8433774	943 37 7	11	KS132 4x70	4 1944148	994 41 4	19	
KS110 3,4x50		3,4 8433859	943 38 5	11	KS132 4x80	4 1944131	994 41 3	19	
KS110 3,4x60		3,4 8434061	943 40 6	11	KS138 4x40	4 8275350	927 53 5	20	
KS110 3,4x65		3,4 8434146	943 41 4	11	KS138 4x50	4 8275374	927 53 7	20	
KS110 3,4x70		3,4 8434221	943 42 2	11	KS138 4x60	4 8275398	927 53 9	20	
KS110 3,4x75		3,4 8434306	943 43 0	11	KS138 4x75	4 8275459	927 54 5	20	
KS110 3,4x80		3,4 8434498	943 44 9	11					
KS110 3x40		3 8486534	948 65 3	11	KS148 2,5x30	2,5 8642077	964 20 7	14	
KS110 3x50		3 8433262	943 32 6	11	KS148 2,5x30	2,5 8644187	964 41 8	14	
KS111 2,5x16		2,5 8494966	949 49 6	13	KS148 2,5x40	2,5 8642152	964 21 5	14	
KS111 2,5x18		2,5 8494539	949 45 3	13	KS148 2,5x40	2,5 8644262	964 42 6	14	
KS111 2,5x20		2,5 8494881	949 48 8	13	KS148 2,5x50	2,5 8642237	964 22 3	14	
KS111 2,5x25		2,5 8394235	939 42 3	13	KS148 2,5x50	2,5 8644347	964 43 4	14	
KS111 2,5x30		2,5 8394310	939 43 1	13	KS148 3x30	3 8644422	964 44 2	14	
KS111 2,5x30		2,5 8495093	949 50 9	13	KS148 3x40	3 8642589	964 25 8	14	
KS111 2,5x35		2,5 8394587	939 45 8	13	KS148 3x40	3 8644507	964 45 0	14	
KS111 2,5x40		2,5 8394662	939 46 6	13	KS148 3x50	3 8642664	964 26 6	14	
KS111 2,5x40		2,5 8495338	949 53 3	13	KS148 3x50	3 8644699	964 46 9	14	
KS111 2,5x45		2,5 8394747	939 47 4	13	KS148 3x60	3 8642749	964 27 4	14	
KS111 2,5x50		2,5 8333241	933 32 4	13	KS148 3x60	3 8644774	964 47 7	14	
KS111 2,5x50		2,5 8394822	939 48 2	13					
KS111 2,5x50		2,5 8495413	949 54 1	13	KS150 1,5x20	1,5 8927501	992 75 0	17	
KS111 2x20		2 8448471	944 84 7	13	KS150 1,5x25	1,5 8672050	967 20 5	17	
KS111 2x25		2 8447832	944 78 3	13	KS150 1,5x25	1,5 8890409	989 04 0	17	
KS111 2x30		2 8448983	944 89 8	13	KS150 1,5x30	1,5 8890423	989 04 2	17	
KS111 3,4x25		3,4 8924906	992 49 0	13	KS150 1,5x30	1,5 8927518	992 75 1	17	
KS111 3,4x25		3,4 8496717	949 67 1	13	KS151 1,5x35	1,5 8738831	973 88 3	17	
KS111 3,4x35		3,4 8924944	992 49 4	13	KS151 1,5x35	1,5 8890508	989 05 0	17	
KS111 3,4x35		3,4 8496755	949 67 5	13	KS151 1,5x40	1,5 8890522	989 05 2	17	
KS111 3,4x40		3,4 8944188	994 41 8	13	KS151 1,5x45	1,5 8738671	973 86 7	17	
KS111 3,4x45		3,4 8923558	992 35 5	13	KS151 1,5x45	1,5 8890546	989 05 4	17	
KS111 3,4x50		3,4 8830023	983 00 2	13	KS153 2,7x20	2,7 8567097	956 70 9	15	

Type	Dimensions/colour/div.	GTIN	Item no.	Page	Type	Dimensions/colour/div.	GTIN	Item no.	Page
KS153 2,7x20	2,7	8566021	956 60 2	15	MZ020 M16x15-16		8009009	900 90 0	123
KS153 2,7x25	2,7	8566106	956 61 0	15	MZ020 M20x19-20		8009023	900 90 2	123
KS153 2,7x25	2,7	8567172	956 71 7	15	MZ020 M25x24-25		8009092	900 90 9	123
KS153 2,7x30	2,7	8566298	956 62 9	15	MZ020 M32x31-32		8008996	900 89 9	123
KS153 2,7x30	2,7	8567257	956 72 5	15	MZ020 M40x39-40		8009207	900 92 0	123
					MZ023 12x0,75	120,75	8009252	900 92 5	63
KS170 M6	Red	8035121	903 51 2	37	MZ023 17x0,75	170,75	8009368	900 93 6	63
KS170 M6	Red	8035121	903 51 2	68	MZ023 25x0,75	250,75	8009481	900 94 8	63
KS170 M6		8035169	903 51 6	37	MZ024 14x3	Black 14	8009269	900 92 6	63
KS170 M6		8035169	903 51 6	68	MZ024 19x2	Black 19	8009375	900 93 7	63
KS171 2,5x60	2,5	8394907	939 49 0	13	MZ024 27x3	Black 27	8009474	900 94 7	63
KS171 2,5x70	2,5	8395034	939 50 3	13	MZ026 L	12	8701828	970 18 2	53
KS171 3,4x100	3,4	8392750	939 27 5	13	MZ027 15x1,3	Black 15	8009283	900 92 8	64
					MZ027 15x1,3	Grey 15	8009559	900 95 5	64
KS207 4	Black	8030096	903 00 9	40	MZ027 15x1,3	Grey 15	8009566	900 95 6	64
KS207 4	Black	8030096	903 00 9	68	MZ028 XL	16	8701842	970 18 4	53
KS209 4x40	4	8497141	949 71 4	31	MZ029 12x0,75	120,75	8009276	900 92 7	63
					MZ029 17x0,75	170,75	8009344	900 93 4	63
					MZ029 25x0,75	250,75	8009351	900 93 5	63
KS221 M6		8035183	903 51 8	69					
KS221 M6		8035183	903 51 8						
					MZ030 14x3	Black 14	8009405	900 94 0	63
KS246 4	Red	8030102	903 01 0	42	MZ030 15	Black	8009391	900 93 9	64
KS246 4	Red	8030102	903 01 0	68	MZ030 19x2	Black 19	8009382	900 93 8	63
					MZ031 E10x10	10	8010050	901 00 5	123
KS258 4x40	4	8497196	949 71 9	31	MZ031 E11x11	11	8010067	901 00 6	123
KS259 4x50	4	8497202	949 72 0	31	MZ031 E12x12	12	8010074	901 00 7	123
					MZ031 E13x13	13	8010081	901 00 8	123
KS266 8x55	8	8571186	957 11 8	120	MZ031 E14x14	14	8010098	901 00 9	123
KS266 8x55	8	8571186	957 11 8	37	MZ031 E15x15	15	8010104	901 01 0	123
KS266 8x70	8	8571209	957 12 0	120	MZ031 E16x16	16	8010111	901 01 1	123
KS266 8x70	8	8571209	957 12 0	37	MZ031 E17x17	17	8010128	901 01 2	123
					MZ031 E18x18	18	8010135	901 01 3	123
KS274 8x15	8	8571063	957 10 6	120	MZ031 E5x5	5	8010005	901 00 0	123
KS274 8x15	8	8571063	957 10 6	37	MZ031 E6x6	6	8010012	901 00 1	123
					MZ031 E7x7	7	8010029	901 00 2	123
KS282 8x18	8	8570943	957 09 4	120	MZ031 E8x8	8	8010036	901 00 3	123
KS282 8x18	8	8570943	957 09 4	37	MZ031 E9x9	9	8010043	901 00 4	123
KS282 8x25	8	8571100	957 11 0	120	MZ032 E28	28	8010487	901 04 8	124
KS282 8x25	8	8571100	957 11 0	37	MZ032 M12	12	8010401	901 04 0	124
KS282 8x30	8	8571124	957 11 2	120	MZ032 M16	16	8010418	901 04 1	124
KS282 8x30	8	8571124	957 11 2	37	MZ032 M20	20	8010425	901 04 2	124
KS282 8x40	8	8571162	957 11 6	120	MZ032 M25	25	8010432	901 04 3	124
KS282 8x40	8	8571162	957 11 6	37	MZ032 M32	32	8010449	901 04 4	124
					MZ032 M40	40	8010456	901 04 5	124
M007S M6	Dusty grey	8330202	933 02 0	112	MZ032 M50	50	8010463	901 04 6	124
					MZ032 M63	63	8010470	901 04 7	124
ME002 1,5x20	1,5	8832485	983 24 8	25	MZ033 M12		8043003	904 30 0	126
ME002 1,6x25	1,6	8832805	983 28 0	25	MZ033 M16		8043010	904 30 1	126
ME002 1,8x30	1,8	8833017	983 30 1	25	MZ033 M20		8043027	904 30 2	126
ME002 2,7x50	2,7	8833956	983 39 5	25	MZ033 M25		8043034	904 30 3	126
ME003 1,2x20	1,2	8835127	983 51 2	24	MZ033 M32		8043041	904 30 4	126
ME003 1,5x20	1,5	8983552	983 55 5	24	MZ033 M40		8043058	904 30 5	126
ME003 1,5x25	1,5	8835714	983 57 1	24	MZ033 M50		8043065	904 30 6	126
ME003 1,6x25	1,6	8836001	983 60 0	24	MZ033 M63		8043072	904 30 7	126
ME003 1,8x30	1,8	8836278	983 62 7	24	MZ034 10,5-12		8043119	904 31 1	127
ME003 2,4x45	2,4	8836940	983 69 4	24	MZ034 12,5-14		8043126	904 31 2	127
ME003 2,7x50	2,7	8837152	983 71 5	24	MZ034 13,5-15		8043133	904 31 3	127
ME003 2x40	2	8836780	983 67 8	24	MZ034 14,5-16		8043140	904 31 4	127
ME004 1,2x15,5	1,2	8838111	983 81 1	24	MZ034 16,5-18		8043157	904 31 5	127
ME004 1,2x20	1,2	8838463	983 84 6	24	MZ034 18,5-20		8043164	904 31 6	127
ME004 1,5x20	1,5	8838890	983 88 9	24	MZ034 20-22		8043171	904 31 7	127
ME004 1,5x25	1,5	8839187	983 91 8	24	MZ034 22-24		8043188	904 31 8	127
ME004 1,6x25	1,6	8839347	983 93 4	24	MZ034 24-26		8043195	904 31 9	127
ME004 1,8x30	1,8	8839774	983 97 7	24	MZ034 26-28		8043201	904 32 0	127
ME004 1x10	1	8837664	983 76 6	24	MZ034 28-30		8043218	904 32 1	127
ME004 1x15	1	8837824	983 78 2	24	MZ034 31-33		8043225	904 32 2	127
ME004 2,4x45	2,4	8840480	984 04 8	24	MZ034 33-35		8043232	904 32 3	127
ME004 2,7x50	2,7	8840640	984 06 4	24	MZ034 36-38		8043249	904 32 4	127
ME004 2,7x55	2,7	8840800	984 08 0	24	MZ034 38-40		8043256	904 32 5	127
ME004 2x40	2	8840138	984 01 3	24	MZ034 40-42		8043263	904 32 6	127
ME004 3x65	3	8841012	984 10 1	24	MZ034 43-45		8043270	904 32 7	127
					MZ034 46-48		8043287	904 32 8	127
MZ019 E18x17-18		8009214	900 92 1	125	MZ034 48-50		8043294	904 32 9	127
MZ019 E22x21-22		8009078	900 90 7	125	MZ034 5-6		8043089	904 30 8	127
MZ019 E24x23-24		8009221	900 92 2	125	MZ034 58-60		8043300	904 33 0	127
MZ019 E28x27-28		8009115	900 91 1	125	MZ034 61-63		8043317	904 33 1	127
MZ019 E35x34-35		8009238	900 92 3	125	MZ034 7-8		8043096	904 30 9	127
MZ019 E40x39-40		8009245	900 92 4	125	MZ034 9-10		8043102	904 31 0	127
MZ019 M16x15-16		8009054	900 90 5	125	MZ038 15x35UG	15	8816614	981 66 1	136
MZ019 M20x19-20		8009108	900 91 0	125	MZ039 7,5x35G	7,5	8816621	981 66 2	136
MZ019 M25x24-25		8009139	900 91 3	125					
					MZ040 7,5x35UG	7,5	8816607	981 66 0	136
MZ020 E18x17-18		8009016	900 90 1	123	MZ041 15x35G	15	8816638	981 66 3	136
MZ020 E22x21-22		8009030	900 90 3	123	MZ042 12-16	Black	8040361	904 03 6	139
MZ020 E24x23-24		8009184	900 91 8	123	MZ042 16-22	Black	8040378	904 03 7	139
MZ020 E28x27-28		8009047	900 90 4	123	MZ042 22-28	Black	8040385	904 03 8	139
MZ020 E35x34-35		8009191	900 91 9	123	MZ042 28-34	Black	8040392	904 03 9	139

Type listing

Structure of the GTIN: Country code **87** Manufacturer code **1367** Individual GTIN **5647589**

Type	Dimensions/colour/div.	GTIN	Item no.	Page	Type	Dimensions/colour/div.	GTIN	Item no.	Page	
MZ042 34-40	Black	8040408	904 04 0	139	OPDZ 25-26x1	Grey 25-26	8818663	981 86 6	119	
MZ042 40-46	Black	8040415	904 04 1	139	OPDZ 28-29	Grey 26-29	8819448	981 94 4	118	
MZ042 46-52	Black	8040422	904 04 2	139	OPDZ 28-29	Grey 28-29	8818649	981 86 4	119	
MZ042 52-58	Black	8040439	904 04 3	139	OPDZ 31-32x11/4	Grey 31-32	8819585	981 95 8	118	
MZ042 58-64	Black	8040446	904 04 4	139	OPDZ 37-38	Grey 37-38	8818656	981 86 5	119	
MZ042 64-70	Black	8040453	904 04 5	139	OPDZ 37-38x11/2	Grey 37-38	8819554	981 95 5	118	
MZ042 70-76	Black	8040460	904 04 6	139	OPDZ 38-40	Grey 38-40	8819608	981 96 0	118	
MZ042 76-82	Black	8040477	904 04 7	139	OPDZ 47-48	Grey 47-48	8946113	994 61 1	118	
MZ042 8-12	Black	8040354	904 03 5	139	OPDZ 50	Grey 50	8946281	994 62 8	118	
MZ042 82-90	Black	8040484	904 04 8	139	OPDZ 53-54	Grey 53-54	8946007	994 60 0	118	
MZ042 90-100	Black	8040491	904 04 9	139	OPDZ 59-60	Grey 59-60	8946021	994 60 2	118	
MZ043 12-16	Black	8040019	904 00 1	140	OPDZ 63	Grey 63	8946298	994 62 9	118	
MZ043 16-22	Black	8040026	904 00 2	140	OPDZ-TF 15-16x5/8	Grey 15-16	8819851	981 98 5	122	
MZ043 22-28	Black	8040033	904 00 3	140	OPDZ-TF 18-19x3/4	Grey 18-19	8819868	981 98 6	122	
MZ043 28-34	Black	8040040	904 00 4	140	OPDZ-TF 20-21	Grey 20-21	8819875	981 98 7	122	
MZ043 34-40	Black	8040057	904 00 5	140	OPDZ-TF 22-23	Grey 22-23	8819882	981 98 8	122	
MZ043 40-46	Black	8040064	904 00 6	140	OPDZ-TF 25-26x1	Grey 25-26	8819493	981 94 9	122	
MZ043 46-52	Black	8040071	904 00 7	140	OPDZ-TF 28-29	Grey 28-29	8819899	981 98 9	122	
MZ043 52-58	Black	8040088	904 00 8	140						
MZ043 58-64	Black	8040095	904 00 9	140	OZ056 M16	Grey	8009610	900 96 1	81	
MZ043 64-70	Black	8040101	904 01 0	140	OZ056 M20	Grey	8009658	900 96 5	81	
MZ043 70-76	Black	8040118	904 01 1	140	OZ056 M25	Grey	8009696	900 96 9	81	
MZ043 76-82	Black	8040125	904 01 2	140	OZ056 M32	Grey	8009719	900 97 1	81	
MZ043 8-12	Black	8040002	904 00 0	140						
MZ043 82-90	Black	8040132	904 01 3	140	OZ060 6x16	Grey 6-16	8044550	904 45 5	114	
MZ043 90-100	Black	8040149	904 01 4	140	OZ061 6x16	Grey 6-16	8044567	904 45 6	114	
MZ045 2/7 10-14		8047018	904 70 1	141	OZ062 6x16	Grey 6-16	8044574	904 45 7	115	
MZ045 2/7 15-21		8047025	904 70 2	141	OZ063 6x16	Grey 6-16	8044581	904 45 8	115	
MZ045 2/7 22-32		8047032	904 70 3	141	OZ064 16-19	Natural 16-19	8551218	955 12 1	93	
MZ045 2/7 6-9		8047001	904 70 0	141	OZ064 20-24	Natural 20-24	8551225	955 12 2	93	
MZ045 8/ 12 22-32		8047070	904 70 7	141	OZ065 16-19	Natural 16-19	8551195	955 11 9	93	
MZ045 8/12 15-21		8047063	904 70 6	141	OZ065 20-25	Natural 20-25	8551201	955 12 0	93	
MZ045 8/12 6-9		8047049	904 70 4	141	OZ066 2,5x135	Natural 2,5	8046028	904 60 2	59	
MZ045 8/12 6-9		8047056	904 70 5	141	OZ066 2,5x135	Black 2,5	8046035	904 60 3	59	
MZ046 20x8G	8	8816508	981 65 0	137	OZ066 2,5x98	Natural 2,5	8046004	904 60 0	59	
MZ046 35x18G	8	8816515	981 65 1	138	OZ066 2,5x98	Black 2,5	8046011	904 60 1	59	
MZ046 35x18G	8	8816522	981 65 2	138	OZ066 2,6x200	Natural 2,6	8046042	904 60 4	59	
MZ047 35x18UG	18	8816539	981 65 3	137	OZ066 2,6x200	Black 2,6	8046059	904 60 5	59	
MZ047 35x18UG	18	8816546	981 65 4	137	OZ066 27x27 n	Natural 27	8046325	904 63 2	60	
MZ048 35x18G	18	8816553	981 65 5	138	OZ066 27x27 s	Black 19	8046332	904 63 3	60	
MZ049 35x18UG	18	8816560	981 65 6	137	OZ066 3,6x140	Natural 3,5	8046066	904 60 6	59	
					OZ066 3,6x140	Black 3,5	8046073	904 60 7	59	
MZ050 2,0x28		8816706	981 67 0	67	OZ066 3,6x200	Natural 3,5	8046080	904 60 8	59	
MZ050 2,5x35		8816713	981 67 1	67	OZ066 3,6x200	Black 3,5	8046097	904 60 9	59	
MZ050 3,1x41		8816720	981 67 2	67	OZ066 3,6x290	Black 3,5	8046110	904 61 1	59	
MZ051 3,0x25		8816737	981 67 3	67	OZ066 3,6x290	Black 4,5	8046134	904 61 3	59	
					OZ066 4,8x200	Natural 4,5	8046127	904 61 2	59	
NAB 5x30	5	8501206	950 12 0	30	OZ066 4,8x290	Natural 4,5	8046141	904 61 4	59	
NAB 5x40	5	8501220	950 12 2	30	OZ066 4,8x290	Black 4,5	8046158	904 61 5	59	
NAB 5x60	5	8501268	950 12 6	30	OZ066 4,8x360	Natural 3,5	8046103	904 61 0	59	
					OZ066 4,8x360	Natural 4,5	8046165	904 61 6	59	
NAS 4x40	4	8550105	950 10 2	30	OZ066 4,8x360	Black 4,5	8046172	904 61 7	59	
NAS 4x50	4	8501046	950 10 4	30	OZ066 7,5x540	Natural 7,5	8046189	904 61 8	59	
NAS 4x60	4	8501060	950 10 6	30	OZ066 7,5x540	Black 7,5	8046196	904 61 9	59	
					OZ067 19x19 n	Natural 19	8046301	904 63 0	60	
NP 10x50	Grey 10	8550440	955 04 4	43	OZ067 19x19 s	Black 19	8046318	904 63 1	60	
NP 12x60	Grey 12	8550525	955 05 2	43	OZ068	Red	8036012	903 60 1	70	
NP 14x60	Grey 14	8550549	955 05 4	43	OZ069	Red	8036005	903 60 0	70	
NP 5x25	Grey 5	8550013	955 00 1	43	OZ070 1,5-0,5	Black	8055488	905 54 8	84	
					OZ070 12-4	Black	8055099	905 50 9	85	
NP 6x30	Grey 6	8550280	955 02 8	43	OZ070 18-6	Black	8055624	905 56 2	84	
					OZ070 18-6	Black	8055105	905 51 0	85	
NP 8x40	Grey 8	8550365	955 03 6	43	OZ070 24-8	Black	8055112	905 51 1	85	
					OZ070 3-1	Black	8055051	905 50 5	85	
OKS 25-40	Natural	25x40	8549307	954 93 0	103	OZ070 3-1	Black	8055495	905 54 9	84
OKS 25-40x3,0x40	Natural	25x40	8549345	954 93 4	103	OZ070 39-13	Black	8055129	905 51 2	85
OKS 25-40x3,0x40	Natural	25x40	8549383	954 93 8	103	OZ070 4,8-1,6	Black	8055068	905 50 6	85
OKS 25-40x3,0x60	Natural	25x40	8549420	954 94 2	103	OZ070 52-13	Black	8055044	905 50 4	85
OKS 25-40x3,0x70	Natural	25x40	8549468	954 94 6	103	OZ070 6-2	Black	8055075	905 50 7	85
					OZ070 9-3	Black	8055617	905 56 1	84	
OPDZ 12-13	Grey 12-13	8819004	981 90 0	119	OZ070 9-3	Black	8055082	905 50 8	85	
OPDZ 15-16x5/8	Grey 15-16/ PP	8819028	981 90 2	118	OZ071 1	Black	8055471	905 54 7	82	
OPDZ 15-16x5/8 Dusty grey	15-16/ PA-6	8818861	981 88 6	119	OZ071 1-16	Black	8055211	905 52 1	82	
OPDZ 15-16x5/8	Grey 15-16/ PA-6	8820055	982 00 5	119	OZ071 1-2	Red	8055181	905 51 8	82	
OPDZ 15-16x5/8	Cream 15-16/ PA-6	8819172	981 91 7	119	OZ071 1-2	Black	8055273	905 52 7	82	
OPDZ 15-16x5/8	Grey 15-16	8818601	981 86 0	119	OZ071 1-4	Red	8055167	905 51 6	82	
OPDZ 18-19x3/4	Grey 18-19/ PP	8819103	981 91 0	118	OZ071 1-4	Black	8055259	905 52 5	82	
OPDZ 18-19x3/4 Dusty grey	18-19/ PA-6	8819141	981 91 4	119	OZ071 1-8	Red	8055143	905 51 4	82	
OPDZ 18-19x3/4	Grey 18-19/ PA-6	8820079	982 00 7	119	OZ071 1-8	Black	8055235	905 52 3	82	
OPDZ 18-19x3/4	Cream 18-19/ PA-6	8819189	981 91 8	119	OZ071 3-16	Red	8055150	905 51 5	82	
OPDZ 18-19x3/4	Grey 18-19	8818618	981 86 1	119	OZ071 3-16	Black	8055242	905 52 4	82	
OPDZ 20-21	Grey 20-21	8819240	981 92 4	118	OZ071 3-32	Red	8055136	905 51 3	82	
OPDZ 20-21	Grey 20-21	8818625	981 86 2	119	OZ071 3-32	Black	8055228	905 52 2	82	
OPDZ 22-23	Grey 22-23	8819370	981 93 7	118	OZ071 3-4	Red	8055198	905 51 9	82	
OPDZ 22-23	Grey 22-23	8818632	981 86 3	119	OZ071 3-4	Black	8055297	905 52 9	82	
OPDZ 25-26x1	Grey 25-26	8819509	981 95 0	118	OZ071 3-64	Black	8055204	905 52 0	82	

Type	Dimensions/colour/div.	GTIN	Item no.	Page	Type	Dimensions/colour/div.	GTIN	Item no.	Page
OZ071 3-8	Black	8055266	905 52 6	82	RV014 1,6x25		1,8 8731030	973 10 3	26
OZ071 3-8	Red	8055174	905 51 7	82	RV014 1,8x32		1,8 8674672	967 46 7	26
OZ071 BOX		8057727	905 77 2	83	RV014 2,1x40		2,1 8674757	967 47 5	26
OZ071 BOX		8055747	905 57 4	83	RV014 2,4x45		2,4 8674832	967 48 3	26
OZ071 BOX		8055730	905 57 3	84	RV014 2,8x50		2,8 8674917	967 49 1	26
OZ073 16-32	Grey7,5	8915058	991 50 5	62	RV014 2,8x55		2,8 8732341	973 23 4	26
OZ073 40-63	Grey7,5	8915072	991 50 7	62					
OZ078 16	Grey16	8551270	955 12 7	93	RV034 1,9x25		1,9 8732402	973 24 0	28
OZ078 16	Grey16	8551294	955 12 9	94	RV034 1,9x30		1,9 8732426	973 24 2	28
OZ078 20	Grey20	8551287	955 12 8	93	RV034 1,9x35		1,9 8732440	973 24 4	28
OZ078 20	Grey20	8551300	955 13 0	94	RV034 2,4x35		2,4 8732501	973 25 0	28
					RV034 2,4x45		2,4 8732549	973 25 4	28
PG037 M7 10x43	Grey	8915300	991 53 0	62	RV034 2,4x50		2,4 8732532	973 25 3	28
PG038 10x50	Grey10	8051244	905 12 4	43	RV034 2,4x60		2,4 8732556	973 25 5	28
PG038 12x60	Grey12	8051251	905 12 5	43	RV034 3,1x50		3,1 8732600	973 26 0	28
PG038 5x25	Grey5	8051213	905 12 1	43	RV034 3,1x60		3,1 8732648	973 26 4	28
PG038 6x30	Grey6	8051220	905 12 2	43	RV034 3,1x75		3,1 8732686	973 26 8	28
PG038 8x40	Grey8	8051237	905 12 3	43	RV037 1,9x30		1,9 8732723	973 27 2	29
PG039 10x60	Grey10	8051299	905 12 9	43	RV037 1,9x35		1,9 8732747	973 27 4	29
PG039 12x70	Grey12	8051305	905 13 0	43	RV037 2,4x45		2,4 8732785	973 27 8	29
PG039 14x75	Grey14	8051312	905 13 1	43	RV037 2,4x50		2,4 8732808	973 28 0	29
PG039 5x32	Grey5	8051268	905 12 6	43	RV037 2,4x60		2,4 8732846	973 28 4	29
PG039 6x36	Grey6	8051275	905 12 7	43	RV037 3,1x75		3,1 8732907	973 29 0	29
PG039 8x50	Grey8	8051282	905 12 8	43	RV038 2,65x50		2,65 8734307	973 43 0	27
					RV038 2,65x50		2,65 8734109	973 41 0	27
PG040 10x60	Grey10	8051350	905 13 5	44	RV038 2x30		2 8734000	973 40 0	27
PG040 12x70	Grey12	8051367	905 13 6	44	RV038 2x30		2 8734154	973 41 5	27
PG040 14x75	Grey14	8051374	905 13 7	44	RV038 2x40		2 8734017	973 40 1	27
PG040 5x32	Grey5	8051329	905 13 2	44	RV038 2x40		2 8734178	973 41 7	27
PG040 6x36	Grey6	8051336	905 13 3	44	RV038 3,35x65		3,35 8732662	973 26 6	27
PG040 8x50	Grey8	8051343	905 13 4	44					
PG041	Grey12,4	8051381	905 13 8	53	SC015 3,5x25		25 8043461	904 34 6	34
PG042	12,631	8051398	905 13 9	53	SC015 3,5x30		30 8043478	904 34 7	34
					SC015 3,5x35		35 8043485	904 34 8	34
PL042 8x50	Natural8	8944027	994 40 2	49	SC015 3,5x40		40 8043492	904 34 9	34
					SC015 3,5x45		45 8043508	904 35 0	34
PR155 3,8x32	3,8	8484776	948 47 7	23	SC015 3,5x50		50 8043515	904 35 1	34
PR155 3,8x40	3,8	8624202	962 42 0	23	SC015 4,5x30		30 8043584	904 35 8	34
PR155 3,8x60	3,8	8718888	971 88 8	23	SC015 4,5x35		35 8043591	904 35 9	34
					SC015 4,5x40		40 8043607	904 36 0	34
PR189 3,4x35	3,4	8993483	993 48 9	23	SC015 4,5x45		45 8043614	904 36 1	34
PR189 3,4x40	3,4	1945886	994 58 8	23	SC015 4,5x50		50 8043621	904 36 2	34
PR189 3,4x45	3,4	8935858	993 58 5	23	SC015 4x25		25 8043522	904 35 2	34
PR189 3,4x50	3,4	1945961	994 59 6	23	SC015 4x30		30 8043539	904 35 3	34
PR189 3,4x60	3,4	8936145	993 61 4	23	SC015 4x35		35 8043546	904 35 4	34
PR189 3,4x65	3,4	8979302	997 93 0	23	SC015 4x40		40 8043553	904 35 5	34
PR189 4,5x100	4,5	1945107	994 51 0	23	SC015 4x45		45 8043560	904 35 6	34
PR189 4,8x90	4,8	1945022	994 50 2	23	SC015 4x50		50 8043577	904 35 7	34
PR189 4x70	4	8936572	993 65 7	23	SC015 5x30		30 8043638	904 36 3	34
PR189 4x80	4	8936817	993 68 1	23	SC015 5x35		35 8043645	904 36 4	34
					SC015 5x40		40 8043652	904 36 5	34
RKK 10x2,0x30	Grey10	8814887	981 48 8	96	SC015 5x45		45 8043669	904 36 6	34
RKK 12x2,0x30	Grey12	8814962	981 49 6	96	SC015 5x50		50 8043676	904 36 7	34
RKK 14x2,5x40	Grey14	8815099	981 50 9	96	SC015 6x40		40 8043683	904 36 8	34
RKK 16x2,5x40	Grey16	8815174	981 51 7	96	SC015 6x50		50 8043690	904 36 9	34
RKK 19x2,5x40	Grey19	8815334	981 53 3	96	SC015 6x60		60 8043706	904 37 0	34
RKK 3x1,2x16	White3	8910022	991 00 2	96	SC016 3,5x15		15 8043713	904 37 1	34
RKK 4x1,8x16	White4	8910107	991 01 0	96	SC016 3,5x20		20 8043720	904 37 2	34
RKK 5x1,8x16	White5	8910299	991 02 9	96	SC016 3,5x25		25 8043737	904 37 3	34
RKK 6x1,8x25	White6	8910374	991 03 7	96	SC016 3,5x30		30 8043744	904 37 4	34
RKK 7x1,8x25	White7	8910459	991 04 5	96	SC016 3,5x35		35 8043751	904 37 5	34
RKK 8x1,8x25	White8	8910534	991 05 3	96	SC016 3,5x40		40 8043768	904 37 6	34
RKK 8x2,0x30	Grey8	8814535	981 45 3	96	SC016 3,5x45		45 8043775	904 37 7	34
					SC016 3,5x50		50 8043782	904 37 8	34
RKS 27-34	Natural	27x34 1952273	995 22 7	101	SC016 4,5x25		25 8043874	904 38 7	35
RKS 27-34x2,0x40	Natural	27x34 1952280	995 22 8	101	SC016 4,5x30		30 8043881	904 38 8	35
RKS 27-34x2,0x50	Natural	27x34 1952297	995 22 9	101	SC016 4,5x35		35 8043898	904 38 9	35
RKS 27-34x2,0x60	Natural	27x34 1952303	995 23 0	101	SC016 4,5x40		40 8043904	904 39 0	35
RKS 27-34x2,5x70	Natural	27x34 1952310	995 23 1	101	SC016 4,5x45		45 8043911	904 39 1	35
RKS 27-34x3,3x40	Natural	27x34 1952327	995 23 2	101	SC016 4,5x50		50 8043928	904 39 2	35
RKS 27-34x3,3x50	Natural	27x34 1952334	995 23 3	101	SC016 4x15		15 8043799	904 37 9	34
RKS 27-34x3,3x60	Natural	27x34 1952341	995 23 4	101	SC016 4x20		20 8043805	904 38 0	34
					SC016 4x25		25 8043812	904 38 1	34
RV001 1,6x20	1,6	8676782	967 67 8	26	SC016 4x30		30 8043829	904 38 2	34
RV001 1,6x25	1,6	8979579	997 95 7	26	SC016 4x35		35 8043836	904 38 3	34
RV001 1,8x32	1,8	8976073	997 60 7	26	SC016 4x40		40 8043843	904 38 4	34
RV001 2,1x40	2,1	8976233	997 62 3	28	SC016 4x45		45 8043850	904 38 5	34
RV001 2,4x45	2,4	8976318	997 63 1	28	SC016 4x50		50 8043867	904 38 6	34
RV001 2,8x50	2,8	8976745	997 67 4	28	SC016 5x30		30 8043935	904 39 3	35
RV001 2,8x55	2,8	8976820	997 68 2	28	SC016 5x35		35 8043942	904 39 4	35
					SC016 5x40		40 8043959	904 39 5	35
RV013 1,6x20	1,6	8673019	967 30 1	27	SC016 5x45		45 8043966	904 39 6	35
RV013 1,6x25	1,6	8673286	967 32 8	27	SC016 5x50		50 8043973	904 39 7	35
RV013 2,1x40	2,1	8673446	967 34 4	28	SC016 5x60		60 8043980	904 39 8	35
RV013 2,8x50	2,8	8674597	967 45 9	28	SC016 6x30		30 8043997	904 39 9	35
RV013 2,8x55	2,8	8673606	967 36 0	28	SC016 6x40		40 8044000	904 40 0	35
RV014 1,6x20	1,6	8730903	973 09 0	26	SC016 6x50		50 8044017	904 40 1	35

Type listing

Structure of the GTIN: Country code **87** Manufacturer code **1367** Individual GTIN **5647589**

Type	Dimensions/colour/div.	GTIN	Item no.	Page	Type	Dimensions/colour/div.	GTIN	Item no.	Page
SC016 6x60		60 8044024	904 40 2	35	SKK 8-10	White 11-15	8816249	981 62 4	98
SC017 3,5x15		15 8044031	904 40 3	35	SKK 8-10	Grey 11-15	8816232	981 62 3	98
SC017 3,5x20		20 8044048	904 40 4	35					
SC017 3,5x25		25 8044055	904 40 5	35	SKKD 16-19	Grey 16-19	8816201	981 62 0	99
SC017 3,5x30		30 8044055	904 40 6	35	SKKD 16-19	Natural 16-19	8816218	981 62 1	99
SC017 3,5x35		35 8044079	904 40 7	35	SKKD 16-19	Cream 16-19	8816225	981 62 2	99
SC017 3,5x40		40 8044086	904 40 8	35					
SC017 4,5x30		30 8044178	904 41 7	35	SP 4x25	Natural 4	8987055	998 70 5	46
SC017 4,5x35		35 8044185	904 41 8	35					
SC017 4,5x40		40 8044192	904 41 9	35	SP 5x25	Natural 5	8987109	998 71 0	46
SC017 4,5x45		45 8044208	904 42 0	35	SP 5x30	Natural 5	8994039	999 40 3	49
SC017 4,5x50		50 8044215	904 42 1	35	SP 5x30	Natural 5	8987062	998 70 6	46
SC017 4x15		15 8044093	904 40 9	35	SP 5x35	Natural 5	8993940	999 39 4	49
SC017 4x20		20 8044109	904 41 0	35	SP 5x35	Natural 5	8991007	999 10 0	46
SC017 4x25		25 8044116	904 41 1	35	SP 5x45	Natural 5	8991199	999 11 9	46
SC017 4x30		30 8044123	904 41 2	35					
SC017 4x35		35 8044130	904 41 3	35	SP 6x35	Natural 6	8993902	999 39 0	46
SC017 4x40		40 8044147	904 41 4	35	SP 6x40	Natural 6	8994060	999 40 6	49
SC017 4x45		45 8044154	904 41 5	35	SP 6x40	Natural 6	8993896	999 38 9	46
SC017 4x50		50 8044161	904 41 6	35	SP 6x55	Natural 6	8994077	999 40 7	49
SC017 5x30		30 8044222	904 42 2	35	SP 6x55	Natural 6	8993971	999 39 7	46
SC017 5x35		35 8044239	904 42 3	35	SP 6x70	Natural 6	8994084	999 40 8	49
SC017 5x40		40 8044246	904 42 4	35	SP 6x70	Natural 6	8982630	998 26 3	46
SC017 5x45		45 8044253	904 42 5	35	SP 6x80	Natural 6	8982647	998 26 4	46
SC017 5x50		50 8044260	904 42 6	35					
SC018 10x100		100 8044406	904 44 0	33	SP 8x100	Natural 8	8983002	998 30 0	46
SC018 10x60		60 8044376	904 43 7	33	SP 8x55	Natural 8	8998273	998 27 1	46
SC018 10x70		70 8044383	904 43 8	33	SP 8x70	Natural 8	8994114	999 41 1	49
SC018 10x80		80 8044390	904 43 9	33	SP 8x70	Natural 8	8982982	998 29 8	46
SC018 12x70		70 8044413	904 44 1	33					
SC018 12x80		80 8044420	904 44 2	33	SPC 10,12x6x55	Grey 6	8633006	963 30 0	108
SC018 6x40		40 8044277	904 42 7	33	SPC 10,12xM6	Grey 10; 12	8634072	963 40 7	106
SC018 6x50		50 8044284	904 42 8	33	SPC 10,12xM6	Grey 10; 12	8635031	963 50 3	108
SC018 6x60		60 8044291	904 42 9	33	SPC 15,16x6x55	Grey 6	8633198	963 31 9	108
SC018 6x80		80 8044307	904 43 0	33	SPC 15,16xM6	Grey 15; 16	8634157	963 41 5	106
SC018 8x100		100 8044369	904 43 6	33	SPC 15,16xM6	Grey 15; 16	8635116	963 51 1	108
SC018 8x40		40 8044314	904 43 1	33	SPC 18,19x6x55	Grey 6	8633273	963 32 7	108
SC018 8x50		50 8044321	904 43 2	33	SPC 18,19xM6	Grey 18; 19	8634232	963 42 3	106
SC018 8x60		60 8044338	904 43 3	33	SPC 20,22x6x55	Grey 6	8633358	963 33 5	108
SC018 8x70		70 8044345	904 43 4	33	SPC 20,22xM6	Grey 20; 22	8635468	963 54 6	108
SC018 8x80		80 8044352	904 43 5	33	SPC 20,22xM6	Grey 20; 22	8634317	963 43 1	106
SC019 3,9x50		50 8044437	904 44 3	32	SPC 25,28xM6	Grey 25; 28	8634584	963 45 8	106
SC019 3,9x60		60 8044444	904 44 4	32					
SC019 3,9x70		70 8044451	904 44 5	32	SP-E 6x35	Natural 6	8987604	998 76 0	46
SC019 3,9x80		80 8044468	904 44 6	32	SP-E 6x40	Natural 6	8987666	998 76 6	46
					SP-E 6x55	Natural 6	8987642	998 76 4	46
					SP-E 6x70	Natural 6	8987628	998 76 2	46
SC020 M4x100		100 8044543	904 45 4	58					
SC020 M5x100		100 8044529	904 45 2	58					
SC020 M6x100		100 8044475	904 44 7	58	SPKK 5x35	Natural 5	8510000	951 00 0	47
SC021 M4x55		55 8044536	904 45 3	58	SPKK 5x45	Grey 5	8510215	951 02 1	47
SC021 M5x100		100 8044499	904 44 9	58	SPKK 5x45	Natural 5	8510192	951 01 9	47
SC021 M5x65		65 8044482	904 44 8	58	SPKK 6x40	Grey 6	8317081	931 70 8	47
SC022 M4x95		95 8044505	904 45 0	57	SPKK 6x40	Natural 6	8317043	931 70 4	47
SC023 M4x70		70 8044512	904 45 1	57	SPKK 6x60	Grey 6	8317258	931 72 5	47
SC024 3,2x15		15 8302001	930 20 0	36	SPKK 6x60	Natural 6	8317128	931 71 2	47
SC024 3,2x25		25 8302018	930 20 1	36	SPKK 6x70	Grey 6	8317265	931 72 6	47
SC024 3,2x40		40 8302025	930 20 2	36	SPKK 6x70	Natural 6	8317203	931 72 0	47
					SPKK 6x80	Natural 6	8317234	931 72 3	47
SCO 13,5-16x6x35	Grey 6	8912132	991 21 3	117	SPKK 8x100	Grey 8	8317531	931 75 3	47
SCO 21x6x35	Grey 6	8912071	991 20 7	117	SPKK 8x100	Natural 8	8317555	931 75 5	47
SCO 9x5x30	Grey 5	8912040	991 20 4	117	SPKK 8x120	Natural 8	8439134	943 91 3	47
SCO 9x6x35	Grey 6	8912057	991 20 5	117	SPKK 8x60	Grey 8	8317418	931 74 1	47
					SPKK 8x60	Natural 8	8317395	931 73 9	47
SCP 10,12x6x40	Grey 6	8630524	963 05 2	107	SPKK 8x80	Grey 8	8317463	931 74 6	47
SCP 15,16x6x40	Grey 6	8630609	963 06 0	107	SPKK 8x80	Natural 8	8317470	931 74 7	47
SCP 18,19x6x40	Grey 6	8630791	963 07 9	107					
SCP 20,22x6x40	Grey 6	8630876	963 08 7	107	SPM 6x40	Natural 6	8600039	960 00 3	47
SCP 25,28x6x40	Grey 6	8631675	963 16 7	107	SPM 6x40	Natural 6	8600039	960 00 3	114
SCP 35x6x50	Grey 6	8661658	966 16 5	107	SPM 6x40	Natural 6	8600039	960 00 3	115
SCP 42x6x50	Grey 6	8661726	966 17 2	107	SPM 6x40	Natural 6	8600039	960 00 3	120
SCP 54x6x50	Grey 6	8661849	966 18 4	107	SPM 6x40	Natural 6	8600039	960 00 3	127
SCP 63x6x50	Grey 6	8661931	966 19 3	107	SPM 6x80	Natural 6	8431152	943 11 5	47
					SPM 6x80	Natural 6	8431152	943 11 5	114
SFP 18	4 8507956	950 79 5		40	SPM 6x80	Natural 6	8431152	943 11 5	115
SFP 18	4 8508045	950 80 4		40	SPM 6x80	Natural 6	8431152	943 11 5	120
SFP 4x14	4 8508007	950 80 0		40	SPM 6x80	Natural 6	8431152	943 11 5	127
SFP 4x18	4 8508106	950 81 0		40	SPM 7/1,0 6x40	Natural 6	8603023	960 30 2	48
SFP 4x22	4 8508205	950 82 0		40	SPM 7/1,5 6x40	Natural 6	8626909	962 69 0	48
SFP 4x27	4 8508250	950 82 5		40	SPM 7/1,5 6x40	Natural 6	8626909	962 69 0	62
SFP 4x35	4 8508281	950 82 8		40	SPM 8x45	Natural 8	8960041	960 04 6	48
SFP 4x40	4 8508335	950 83 3		40	SPM 8x60	Natural 8	8943884	943 88 7	48
					SPM 8x70	Natural	8610007	961 00 0	113
SKK 11-15	White 11-15	8816256	981 62 5	98	SPM 8x80	Natural 8	8943891	943 89 5	48
SKK 11-15	Grey 11-15	8816263	981 62 6	98					
SKK 16-19	Natural 16-19	8816287	981 62 8	98	SPP 5x35	Brown 5	8700258	970 02 5	48
SKK 16-19	Grey 11-15	8816270	981 62 7	98	SPP 5x35	White 5	8700418	970 04 1	48
SKK 16-19	Cream 16-19	8816393	981 63 9	99	SPP 5x45	Brown 5	8700333	970 03 3	48

Type	Dimensions/colour/div.	GTIN	Item no.	Page
SPP 5x45	White5	8700845	970 08 4	48
SPTB 6x40	Natural6	8994022	999 40 2	49
SPTB 6x50	Natural6	8994015	999 40 1	49
SPTB 6x60	Natural6	8994008	999 40 0	49
STB 15-16x5/8	Grey 15-16	8819974	981 99 7	121
STB 18-19x3/4	Grey 18-19	8819981	981 99 8	121
STB 20-21	Grey 20-21	8819998	981 99 9	121
STB 22-23	Grey 22-23	8820000	982 00 0	121
STB 25	Grey 25	8820024	982 00 2	121
STB 28-29	Grey 28-29	8820017	982 00 1	121
STB 31-32	Grey 31-32	8820130	982 01 3	121
STD 4x12	Grey 4-12	8549222	954 92 2	92
STS 13	Grey	8320906	932 09 0	95
STS 28	Grey	8320913	932 09 1	95
STS 40	Grey	8320920	932 09 2	95
TF 5x30	Red5	8701217	970 12 2	52
TF 6x40	Red6	8701651	970 16 5	52
UNO 30x110x19	Red	8011835	901 18 3	113
UNO 40-125xM8	Dusty grey	8632627	963 26 2	112
UNO 40-125xM8	Dusty grey	8632641	963 26 4	112
UNO B	Dusty grey	8632559	963 25 5	112
VK 6x40	White6	8550938	955 09 3	54
VK 6x40	Grey6	8550952	955 09 5	54
VK 6x40	Black6	8550976	955 09 7	54
VK 6x40	Brown6	8550945	955 09 4	55
VK 6x40	Light brown6	8550969	955 09 6	55
VKKH 6x40	Black6	8550990	955 09 9	56
VKKL 6x40	Black6	8550983	955 09 8	56
VKKL 8x40	Black8	8551010	955 10 1	56
WKK 10-14	Grey 10-14	1952167	995 21 6	97
WKK 10-14x2,0x25	Grey 10-14	8909088	990 90 8	97
WKK 10-14x2,0x30	Grey 10-14	8909057	990 90 5	97
WKK 10-14x2,0x40	Grey 10-14	8909064	990 90 6	97
WKK 13,5-17x2,0x40	Grey 14-17	8909095	990 90 9	97
WKK 14-17	Grey 14-17	8952190	995 21 9	97
WKK 17-21	Grey 17-21	8952206	995 22 0	97
WKK 4-7	Grey 4-7	1952143	995 21 4	97
WKK 4-7x2,0x18	Grey 4-7	1914035	991 40 3	97
WKK 4-7x2,0x25	Grey 4-7	8909002	990 90 0	97
WKK 7-12	Grey 7-12	8952152	995 21 5	97
WKK 7-12x2,0x18	Grey 7-12	8909101	990 91 0	97
WKK 7-12x2,0x25	Grey 7-12	8909019	990 90 1	97
WKK 7-12x2,0x35	Grey 7-12	8909033	990 90 3	97
WKK 7-12x2,0x45	Grey 7-12	8909071	990 90 7	97
ZZ008 3,4x65	3,4	8777458	977 74 5	26
ZZ008 3,4x80	3,4	8777298	977 72 9	26
ZZ008 3x65	3	8415237	941 52 3	26
ZZ016 3,4x65	3,4	8951261	995 12 6	26
ZZ016 3,4x80	3,4	8711162	971 11 6	26
ZZ019 3,4x65	3,4	8730743	973 07 4	26
ZZ019 3,4x80	3,4	8730828	973 08 2	26
ZZ023 2,5x25	2,5	8702795	970 27 9	26
ZZ023 2,9x50	2,9	8703082	970 30 8	26

Delivery conditions:

- Delivery times according to order confirmation. Additional agreements and/or changes must be made in writing.
- Articles indicated with an * are not a part of the stock range. These articles must be produced specially.
- We shall not be held responsible for delivery time delays due to unforeseen technical problems or Acts of God (e.g. industrial disputes).
- Deliveries are always made from our central warehouse in the Netherlands. All the delivery time details should be taken as "from the factory" and any necessary transport times should also be taken into account. These are usually 3–5 days, depending on the country of the recipient.
- The contractual partner is obliged to inform us of special conditions regarding the delivery (e.g. truck size, separate warehouse, delivery times, etc.) when placing their order. We shall not be responsible for any delays in delivery as a result of this. Any additional costs incurred through non-observance of the above delivery conditions will be invoiced by the contractual partner at a later date.
- Delivered free – German border: €250
Order value under €250 = €25 delivery costs (flat rate)
- Delivered free – Swiss border: €1,500
Order value under €1,500 = Delivery costs by agreement
- Delivered free – Austrian border: €1,500
Order value under €1,500 = €40 delivery costs (flat rate)
- All the above prices are net prices plus the rate of statutory VAT valid at the time of invoicing.
- Payment must always be made within 30 days (§286 German Civil Code). Any discounts shall require prior agreement or must be specified as a part of the business relationship.
- Deliveries shall only be made in full containers (shrink wrap / box). Refer to our catalogue or the order confirmation for the sizes/contents. We reserve the right to make appropriate changes to the order quantities.
- The weight and quantity per packaging unit may deviate slightly from the details in the catalogue, the order confirmation and/or the delivery note.
- Excess or insufficient deliveries of up to 10% of the ordered quantities shall be permitted and present no grounds for complaint by the contractual partner.
- The recipient of the goods shall check them immediately on arrival for the correctness of the type and scope. Complaints made later with regard to obvious defects shall not be taken into account.
- Should the recipient of the good be late in accepting it, then we shall be authorised to invoice the recipient for resulting damage and any additional costs. This shall also include possible loss or depreciation of the goods.
- The goods shall remain our property up to the full payment of the purchase price and all connected costs and expenses. In the case of partial payment delay, we shall be authorised to collect the goods without the agreement of the purchaser.
- Our conditions of delivery are a part of our general terms and conditions of business and make no claim to completeness. Refer to the general terms and conditions of business for all other preconditions for business relationships and additions

Don Quichotte B.V.

PO Box 60, 5700 AB Helmond
Industrial Zone 9081
Gerstdijk 17, 5704 RG Helmond
The Netherlands
Tel.: +31 (0)492 745 000
Fax.: +31 (0)492 745 099
E-mail: info@don-quichotte.nl
www.don-quichotte.nl

Germany

German Branch
Paffrather Strasse 80
51465 Bergisch Gladbach
Germany
Tel.: +49 (0)2202 955 39-0
Fax.: +49 (0)2202 56096
E-mail: info@don-quichotte.de
www.don-quichotte.de

France

French Branch
Horizon 2000 - Mach 3
Avenue des Hauts Grigneux
76420 Bihorel les Rouen
France
Tel.: +33 (0)235 617 077
Fax.: +33 (0)235 612 963
E-mail: info@don-quichotte.fr
www.don-quichotte.fr